

Shopping dos
Elevadores
www.shpe.com.br



CATÁLOGO DE
PRODUTOS

LEGENDA DE CORES

APLICAÇÃO ATLAS E SCHINDLER

APLICAÇÃO OTIS

APLICAÇÃO DE USO GERAL

APLICAÇÃO SUR E THYSSEN

APLICAÇÃO REAL

APLICAÇÃO SCANCHIP

APLICAÇÃO INFOLEV

APLICAÇÃO SIMPAC, ELETEM E INSTEL

APLICAÇÃO ADDTECH

APLICAÇÃO SCHMERSAL

ÍNDICE

A		E		N	
Alavanca.....	2	Encoder	49	Nivelador de óleo	75
Alavanca	2	Engrenagem.....	50	O	
Amortecedor AK-1	3	Engrenagem otis.....	50	Óleo lubrificante	75
Amortecedor de poliuretano	3	Engrenagem AT 120.. ..	50	P	
Amortecedor hidráulico	3	Engrenagem tke.....	50	Painel de incêndio	76
B		Engrenagem meia lua	50	Parafuso	76
Barreira eletrônica	4	F		Pastilha braille	77
Bobina	4	Fechadura triangular	51	Pastilha para seta	78
Borracha	5	Fecho	51	Pesador de carga	78
Botão	7	Fita seletora	52	Pinos	79
Botoeira	19	Fixador da correia AT 120.....	52	Placa de sinalização	79
Botoeira de segurança	21	Fonte chaveada.....	53	Placa eletrônica	83
Bujão ilhós	22	Freio.....	53	Ponteira para cabo operador	94
C		G		Porta de pavimento	94
Cabo acionador	22	Garfo de borracha	54	Porta escova para demarrador	94
Cabo transportador	23	Guarda corpo	57	Prensa cabo	94
Cabo de comando	23	I		Protetor antissurto	94
Capacitor.....	24	Imã flexível	57	Puxador de porta	95
Cabo operador	23	Intercomunicador	57	R	
Caixa de passagem	23	IPD	58	Reed switch	96
Caixa plástica	23	Isolador	59	Relê	95
Calço	24	L		Resistor de frenagem	97
Carvão	24	Lâmina	59	Roldana	96
Chave de destravar trinco	26	Lâmpada baioneta	60	Roller Guide	105
Chave de segurança	27	Lâmpada LED	60	S	
Chave elétrica	27	Lâmpada rosca	61	Sapata	106
Chave seletora	27	Lâmpada torpedo	61	Seta display	107
Chaveta	27	Limitador de velocidade	61	Suporte correção.....	107
Clip para guia / tirante	28	Limite	61	Suporte	108
Coletor de óleo	28	Lona de freio	68	Suspensão de porta	111
Contato de porta.....	29	Lubrificador de guia	68	T	
Contato	31	Luz de emergência	69	Teclados	113
Contator	35	M		Trincos.....	114
Correção	36	Manipulador Joystick	70	Tirantes	113
Correia	45	Micro switch	71	Termostato	113
Cinta de tração.....	46	Miolo de trinco	71	U	
D		Mola aérea	72	URM	115
Display.....	46	Mola mecânica	73	V	
Display.....	47	Mola paracheque	76	Ventilador	115
Dictador	48			Visor acrílico	116
Disco de freio	48				
Distorcedor guia.....	49				
Display LCD	48				

ALAVANCA



SHPE 103 - Alavanca para fechomatic (Bilateral)

ALAVANCA - ATLAS

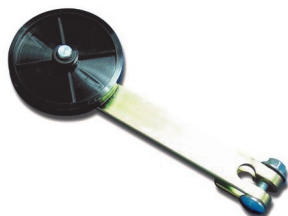

SHPE 104 - Alavanca para trinco pantográfico

ALAVANCA - KONE



SHPE 105 - Alavanca para fechador Dorma com rolamento

ALAVANCA - OTIS



SHPE 106 - Alavanca para fechador Dorma com rolamento

ALAVANCA - REAL



SHPE 107 - Alavanca para fechador com lado reversível

ALAVANCA - SCHINDLER



SHPE 108 - Alavanca para trinco EVR

ACOPLAMENTO DO ENCODER



SHPE 1189 - Acoplamento de alumínio sem a borracha

ALAVANCA - SUR

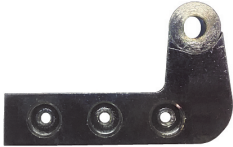

SHPE 109 - Braço superior porta sur direita(Foto)
SHPE 110 - Braço superior porta sur esquerda

ALAVANCA - SUR



SHPE 1174 - Braço inferior porta sur direita(Foto)
SHPE 1175 - Braço inferior porta sur esquerda

AMORTECEDOR - OTIS

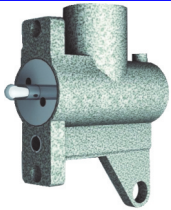

SHPE 111 - Amortecedor AK-1

AMORTECEDOR DE MÁQUINA

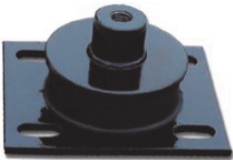

SHPE 112- Amortecedor para base de máquinas - Carga
até 6.000 Kg

AMORTECEDOR DE POLIURETANO



SHPE 113 - Ø 65X80 mm 200 a 1.200 Kg
SHPE 114 - Ø 80X100 mm 200 a 2.000 Kg
SHPE 115 - Ø 100X160 mm 500 a 3.000Kg
SHPE 116 - Ø 130X200 mm 1.000 a 4.000 Kg

AMORTECEDOR CELASTRO



SHPE 1177- Para-choque de celastro Ø100X160 mm 500 a 3.000 Kg
SHPE 1178- Para-choque de celastro Ø130X90 mm 500 a 3.000 Kg

AMORTECEDOR HIDRÁULICO



SHPE 117- Com mola externa 600~3.000 kg ≤1 m/s

AMPLIFICADOR MSCC



SHPE 118 - Amplificador MSCC tke

ANEL ORING



SHPE 1192 - Anel oring do limitador de velocidade GBP schindler

BARREIRA ELETRÔNICA



SHPE 119 - LC 17/G
SHPE 120 - LC 17/G - 1 METRO

110/220 - Possui chave seletora de tensão cabos flexíveis e buzzer

BOBINA - ATLAS

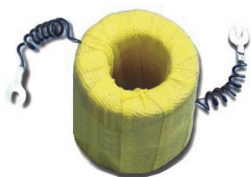

SHPE 121 - Bobina para freio Atlas

BOBINA - ATLAS



SHPE 122 - Bobina para chave 11

BOBINA - THYSEN



SHPE 123 - Bobina freio duplo EM 33

BOBINA - THYSEN



SHPE 124 - Bobina freio maquina EM 33

BOBINA - SUR



SHPE 125 - Bobina para freio de máquina Sur EM 25 115V

BOBINA - SUR

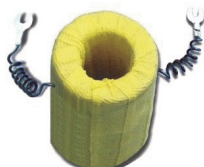

SHPE 126- Bobina para freio do operador 110V
SHPE 127 - Bobina para freio do operador 60V

BOBINA - SUR



SHPE 128- Bobina para chave de comutação 110V

BOBINA - SCHINDLER



SHPE 129 - Bobina dupla para maquinas W163 / W140

BORRACHA - ATLAS



SHPE 130 - Borracha amortecedora para corrente do operador

BORRACHA - ATLAS



SHPE 131- Borracha para corredeira binóculo

BORRACHA - KONE



SHPE 132 - Borracha de acoplamento VK24

BORRACHA - OTIS

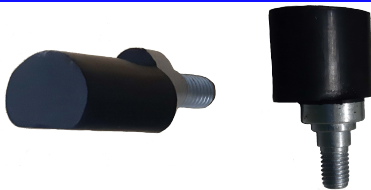

SHPE 133 - Borracha batente para operador de porta 9550T

BORRACHA - OTIS



SHPE 134 - Amortecedor de borracha para batente

BORRACHA - ATLAS



SHPE 1190 - Cruzeta de borracha do encoder

BORRACHA - SCHINDLER

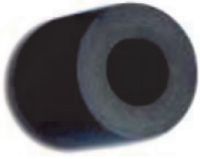

SHPE 135 Borracha de acoplamento pequena (30x30x14 mm)
SHPE 136 - Borracha de acoplamento grande (40x45x20 mm)

BORRACHA - SCHINDLER



SHPE 137 - Borracha para batente de porta

BORRACHA - THYSSEN



SHPE 138 - Borracha de acoplamento com eixo (25x65 mm)
SHPE 139 - Borracha de acoplamento com eixo (40x85 mm)

BORRACHA - SUR

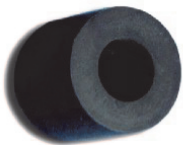

SHPE 140 - Borracha de acoplamento grande (40x45x20 mm)

BORRACHA - SUR



SHPE 141 - Borracha de acoplamento EM62/71/81

BORRACHA - SUR



SHPE 142 - Roldana de borracha para trinco de porta automática 41 x 19 x 39 mm

Com bucha

BORRACHA - SCHINDLER



SHPE 143 - Borracha batente operador QK8

BATENTE DE BORRACHA



SHPE 144 - Borracha para batente Otis

BOTÃO - THYSSEN

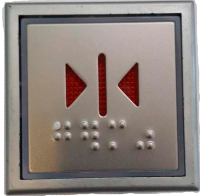

SHPE 248 - Botão New soft pres fechar porta azul

SHPE 249 - Botão New soft pres fechar porta vermelho

BOTÃO - THYSSEN



SHPE 250 - Botão New soft press abre porta azul

SHPE 251 - Botão New soft press abre porta vermelho

BOTÃO - THYSSEN



SHPE 241 - Botão New soft pres seta azul

SHPE 242 - Botão New soft pres seta vermelho

BOTÃO - THYSSEN

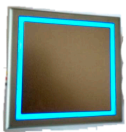

SHPE 148 - Botão new soft press liso azul

BOTÃO - THYSSEN

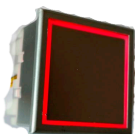

SHPE 149 - Botão new soft pres liso vermelho

BOTÃO - THYSSEN



SHPE 155 - Botão New soft Press interfone

BOTÃO - THYSSEN



SHPE 175 - Botão alarme new soft press

BOTÃO - THYSSEN



SHPE 243 - Botão new sof press azul
SHPE 244 - Botão new soft press vermelho

Numeros ou letras

BOTÃO - THYSSEN

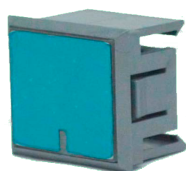

SHPE 156 - Botão Soft Press Capa

BOTÃO - THYSSEN



SHPE 157 - Botão antivandalico thyssen
consulte disponibilidade de letras e numeros

BOTÃO - THYSSEN



SHPE259 - Botão antivandalico abre porta

BOTÃO - THYSSEN



SHPE 260 - Botão antivandalico fecha porta

BOTÃO - THYSSEN

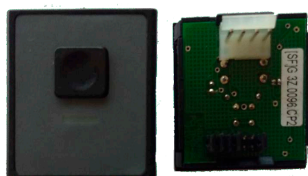

SHPE 160 - Botão mm SF1

- Usado no MCP6

BOTÃO - THYSSEN

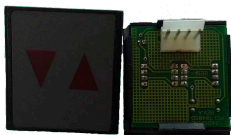

SHPE 161 - Botão seta SF1

BOTÃO - THYSSEN



SHPE 163 - Botão seta grafite SF2

BOTÃO - THYSSEN



SHPE 150 - Display grafite serial ful 2 mcp7
SHPE 151 - Display paralelo para mcp5

BOTÃO - THYSSEN



SHPE 158 - Botão Micromover sf2 grafite

BOTÃO - THYSSEN



SHPE 231 - Botão Micro mover grafite MCP3 e MCP5
SHPE 232 - Botão Micro mover ouro MCP3 e MCP5

BOTÃO - THYSSEN

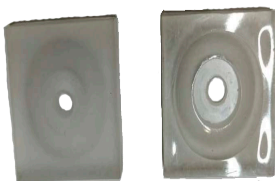

SHPE 176 - Acrílico do botão capacitivo

BOTÃO - THYSSEN

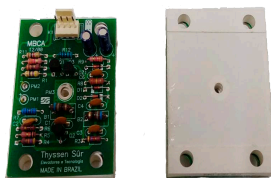

SHPE 193 - Modulo capacitivo auxiliar SF2

BOTÃO - THYSSEN

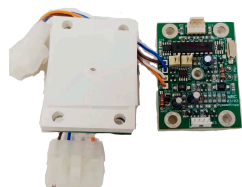

SHPE 194 - Modulo botão capacitivo mestre Sf2

BOTÃO - THYSSEN



SHPE 195 - Botão Sky clas escravo

BOTÃO - THYSSEN

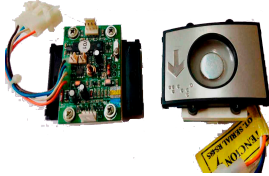

SHPE 145 - Botão Sky clas mestre

BOTÃO - THYSSEN



SHPE 166 - Modulo botão duplo SF2

BOTÃO - THYSSEN



SHPE 177 - Modulo botão SF1 duplo

- Com jumper de configuração

BOTÃO - THYSSEN



SHPE 233 - Modulo botão alarme/lotado/ auxiliar sf2

BOTÃO - ATLAS



SHPE 275 - Botão duplo micro mover ouro

Produto sob encomenda, temos todas as numerações

BOTÃO - THYSSEN

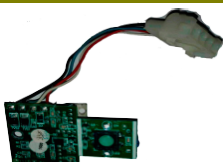

SHPE 225 - Modulo botão MSPM vermelho

BOTÃO - THYSSEN

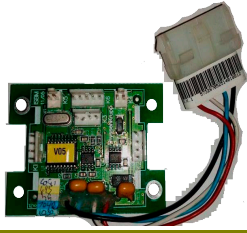

SHPE 226 - Modulo botão ISBM

BOTÃO - THYSSEN

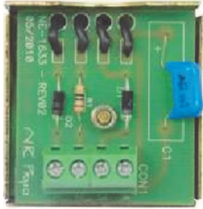

SHPE227 Circuito capacitivo 110 volts

SHPE228 Circuito capacitivo 24 volts

BOTÃO - THYSSEN

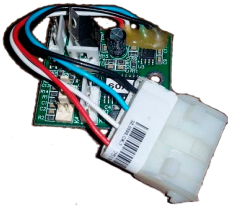

SHPE 229 - Modulo botão BSLP

BOTÃO - THYSSEN

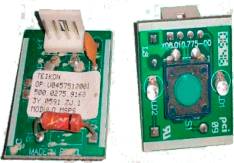

SHPE 230- Botão MSPS vermelho

BOTÃO - THYSSEN

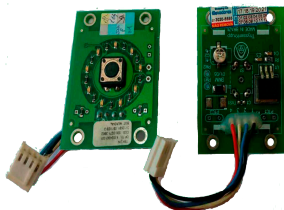

SHPE 234 - Modulo botão BMM azul

SHPE 235- Modulo botão BMM vermelho

SHPE 236 - Modulo botão BMM laranja

BOTÃO - THYSSEN

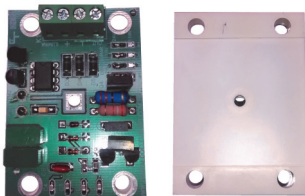

SHPE 263 - Módulo botão capacitivo com LED 24V

SHPE 264 - Módulo botão capacitivo com LED 110V

BOTÃO - THYSSEN

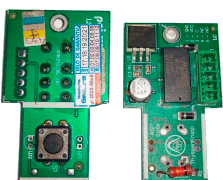

SHPE 1168 - Modulo MASP

BOTÃO - THYSSEN



SHPE 252 - Painel inox para botão antivandalico tke

temos todas as letras e numeros sob encomenda

BOTÃO - THYSSEN



SHPE 253 - Painel inox braile para botão top line tke

temos todas as letras e numeros sob encomenda

BOTÃO - THYSSEN



SHPE 254 - Etiqueta Sky class grafite letra branca

temos todas as letras e numeros sob encomenda

BOTÃO - THYSSEN



SHPE 247 - Etiqueta botão micro mover

temos todas as letras e numeros cor branca ou preta
observação: produto sob encomenda

BOTÃO - INOX

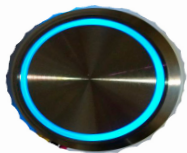

SHPE 146 - Botão faceado azul

BOTÃO - INOX



SHPE 147 - botão faceado vermelho

BOTÃO - SHPE



SHPE 197 - Botão azul com braille 12/24V

Temos todas as nomenclaturas exigidas pela norma

BOTÃO - SHPE

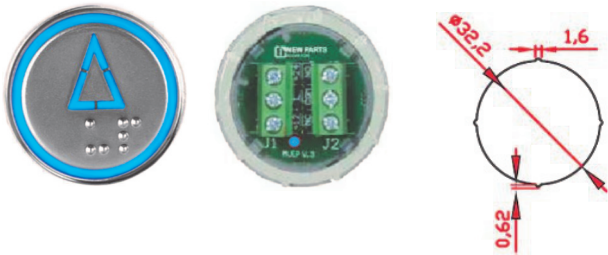

SHPE 198 - Botão azul com braille 12/24V - seta sobe

BOTÃO - SHPE

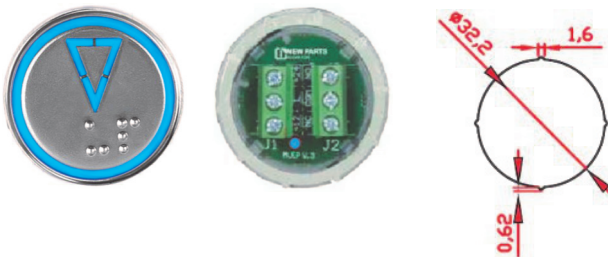

SHPE 199 - Botão azul com braille 12/24V - seta desce

BOTÃO - SHPE

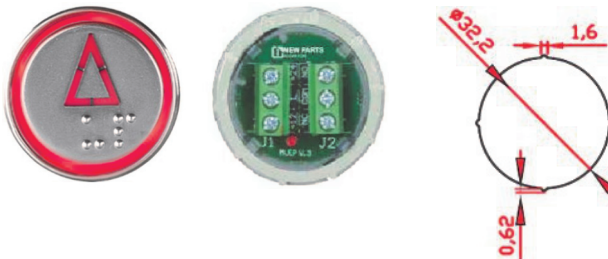

SHPE 200 - Botão vermelho com braille 12/24V - seta sobe

BOTÃO - SHPE

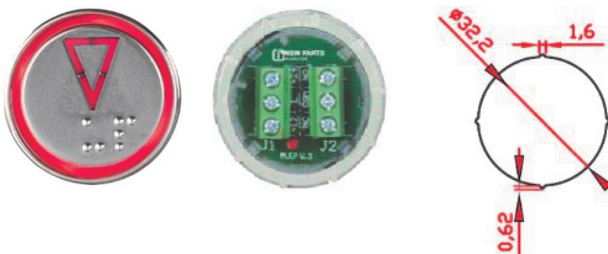

SHPE 201 - Botão vermelho com braille 12/24V - seta desce

BOTÃO - SHPE

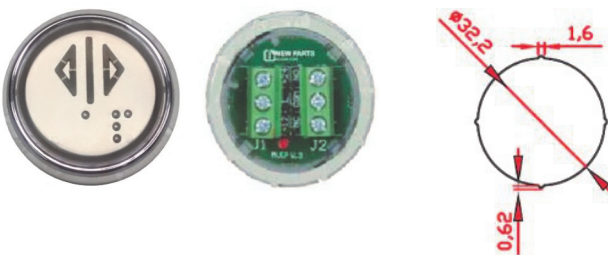

SHPE 202 - Botão vermelho com braille 12/24V - abre porta
SHPE 203 - Botão azul com braille 12/24V - abre porta

BOTÃO - SHPE



SHPE 204 - Botão vermelho com braille 12/24V - fecha porta
SHPE 205 - Botão azul com braille 12/24V - fecha porta

BOTÃO - SHPE



SHPE 206 - Botão vermelho com braille 12/24V - alarme
 SHPE 207 - Botão azul com braille 12/24V - alarme

BOTÃO - SHPE



SHPE 208 - Botão vermelho com braille 12/24V - interfone
 SHPE 209 - Botão azul com braille 12/24V - interfone

BOTÃO - SHPE



SHPE 210 - Botão vermelho com braille 24V para furo

Ø35,6 mm

BOTÃO - OTIS

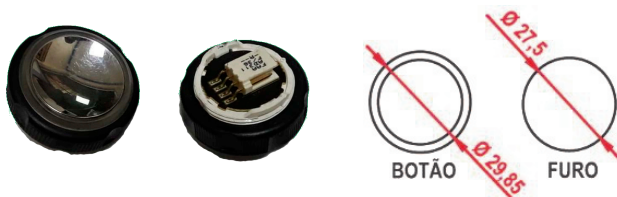

SHPE 1153 - Botão neo FAAAD311F original vermelho
 SHPE 1154 - Botão neo FAAAD313F original azul

BOTÃO - OTIS

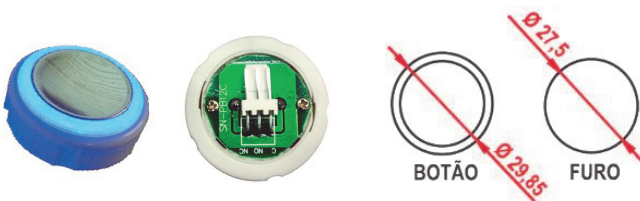

SHPE 211 - Botão redondo côncavo azul 12V - 3 vias
 SHPE 212 - Botão redondo côncavo azul 24V - 3 vias

BOTÃO - OTIS



SHPE 213 - Botão redondo côncavo azul 24V - 4 vias

BOTÃO - OTIS



SHPE 214 - Botão redondo côncavo vermelho 12V - 3 vias
 SHPE 215 - Botão redondo côncavo vermelho 24V - 3 vias

BOTÃO - OTIS

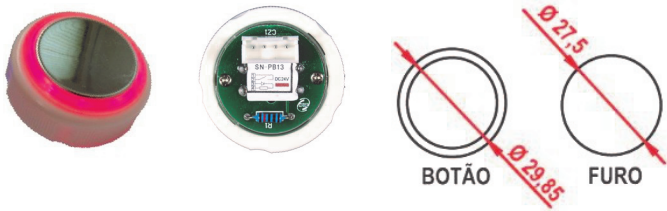

SHPE 216 - Botão redondo côncavo vermelho 24V - 4 vias

BOTÃO - OTIS

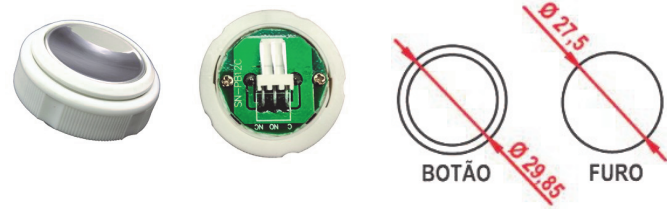

SHPE 217 - Botão redondo côncavo fecha porta

BOTÃO - OTIS

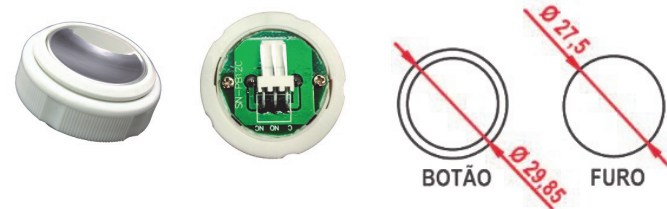

SHPE 218 - Botão redondo côncavo abre porta

BOTÃO - OTIS

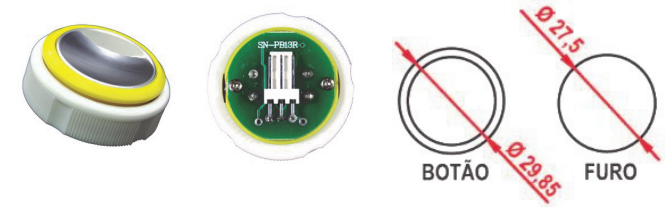

SHPE 219 - Botão redondo côncavo alarme

BOTÃO - OTIS

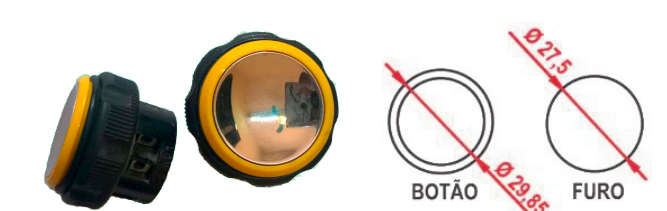

SHPE 1155 - Botão concavo alarme amarelo original

BOTÃO - OTIS

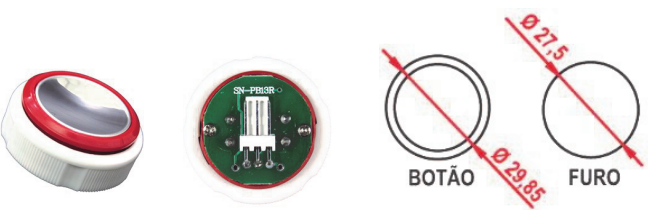

SHPE 220 - Botão redondo côncavo emergência

BOTÃO - OTIS

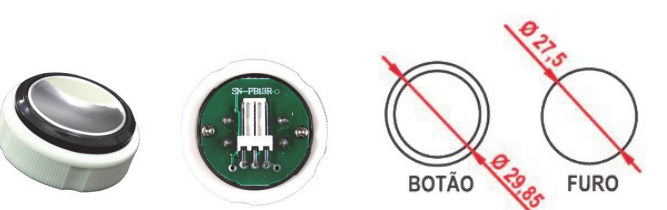

SHPE 221 - Botão redondo côncavo interfone

BOTÃO - OTIS

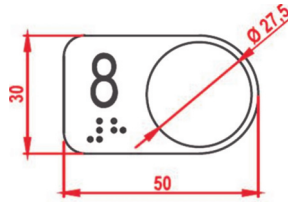
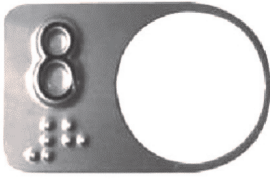

SHPE 222 - Pastilha braille inox 50 x 30 mm

BOTÃO - OTIS

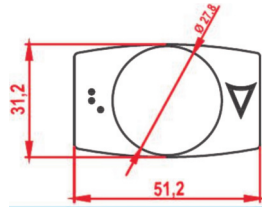
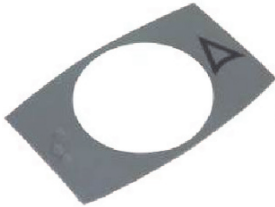

SHPE 223- Pastilha braille de policarbonato seta sobe
SHPE 224- Pastilha braille de policarbonato seta desce

BOTÃO - ATLAS



SHPE 167 - Botão ELX neo fecha porta

BOTÃO - ATLAS



SHPE 168 - Botão ELX neo alarme

BOTÃO - ATLAS



SHPE 169- Botão ELX neo ventilador

BOTÃO - ATLAS

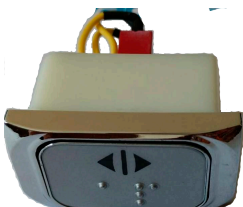

SHPE 170 - Botão ELX neo abre porta

• Sob encomenda, temos todos os modelos

BOTÃO - ATLAS



SHPE 152 - Botão D line 228 led azul
 SHPE 153 - Botão D line 229 led azul varredura

BOTÃO - ATLAS



SHPE 159 - Botão D Line alarme

BOTÃO - ATLAS



SHPE 154 - Botão neo lift unha

BOTÃO - KONE



SHPE 181 - Botão 3 leds 60V preto
 SHPE 182 - Botão 3 leds 24V cinza
 SHPE 183 - Botão 1 led 24V cinza
 SHPE 184 - Botão 1 led 60V preto

BOTÃO - KONE



SHPE 185 - Corpo para botão com 1 furo - cinza
 SHPE 186 - Corpo para botão com 1 furo - preto
 SHPE 187 - Corpo para botão com 3 furos - cinza
 SHPE 188 - Corpo para botão com 3 furos - preto

BOTÃO - KONE



SHPE 189 - Corpo para botão sem furo - cinza
 SHPE 190 - Corpo para botão sem furo - preto

BOTÃO - KONE



SHPE 191- Núcleo gravado para botão
SHPE 192- Núcleo liso para botão

BOTÃO - USO GERAL

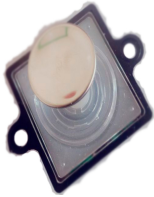

SHPE 173 - Botão ELX 300 azul
SHPE 174 - Botão ELX 300 vermelho

BOTÃO - USO GERAL

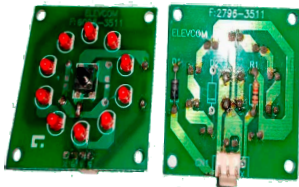

SHPE 237 - Modulo botão ELX 300 vermelho
SHPE 238 - Modulo botão ELX 300 azul

BOTÃO - USO GERAL



SHPE 178- Botão ELX 400 AZUL
SHPE 179 - Botão ELX 400 vermelho

BOTÃO - USO GERAL



SHPE 245- Botão ELX NEO azul
SHPE 246 - Botão ELX NEO vermelho

Temos todas as letras e números sob encomenda

BOTÃO - SHINDLER

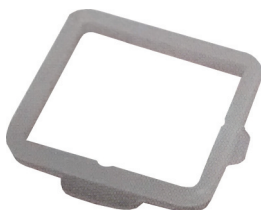

SHPE 239 - Guia de nylon baixa para botão quadrado
SHPE 240 - Guia de nylon alta para botão quadrado

BOTOEIRA



SHPE 162 Acabamento Concavo ELX 300

BOTOEIRA

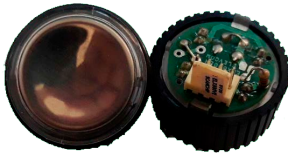

SHPE 164 - Botão ELX600 azul
SHPE 165 - Botão ELX600 vermelho

BOTOEIRA

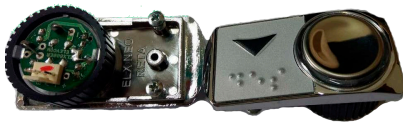

SHPE 1156 - Botão ELX NEO azul sobe
SHPE 1157 - Botão ELX NEO azul desce

BOTOEIRA

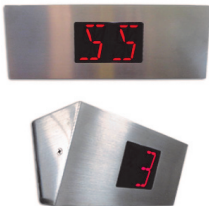

SHPE 255 - Espelho de sobrepor em aço inox reclinado

BOTOEIRA



SHPE 256 - Espelho de sobrepor em latão escovado e
envernizado

BOTOEIRA



SHPE 257 - Visor tridimensional azul

BOTOEIRA



SHPE 258 - Visor tridimensional vermelho

BOTOEIRA

SHPE 171 - Botoeira loop sensitiva

BOTOEIRA

SHPE172- Loop MM 2 botões

BOTOEIRASHPE180 - Painel pa
consultar letras e numeros**BOTOEIRA****BOTOEIRA**

SHPE 262 - Etiqueta braile botão ELX 600

Consultar numeros e letras

BOTOEIRA

SHPE 265- Display TK99 plus com moldura SF2

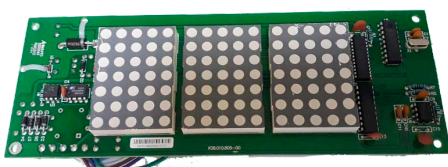
BOTOEIRA

SHPE 266 - Display indicador TK99 plus SF2

BOTOEIRA

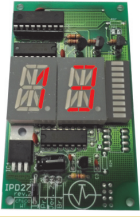

SHPE 267 - Indicador alfanumérico 20 mm vermelho
SHPE 268 - Indicador alfanumérico 20 mm azul

BOTOEIRA

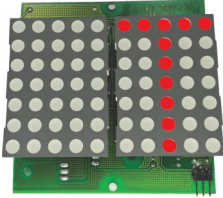

SHPE 269 - Indicador matricial 50 mm vermelho
SHPE 270 - Indicador matricial 50 mm azul

BOTOEIRA

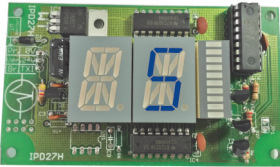

SHPE 271 - Indicador alfanumérico 20 mm horizontal vermelho
SHPE 272 - Indicador alfanumérico 20 mm horizontal azul

BOTOEIRA

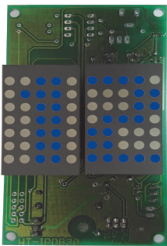

SHPE 273 - Indicador matricial 30 mm vermelho
SHPE 274 - Indicador matricial 30 mm azul

BOTOEIRA



SHPE 196 - Botão vermelho com braille 12/24V

Temos todas as nomenclaturas exigidas pela norma

BOTOEIRA DE SEGURANÇA



SHPE 276 - Botoeira PAP com grade compacta

BOTOEIRA DE SEGURANÇA



SHPE 277 - Botoeira PAP com grade

BOTOEIRA DE SEGURANÇA



SHPE 278 - Botoeira PAP sem grade

BOTOEIRA DE SEGURANÇA



SHPE 279 - Botoeira PAP sem grade em ABS

BOTOEIRA DE SEGURANÇA



SHPE 280 - Botoeira de inspeção Clicfix 19753601

BRAÇO DO FECHO GEMICLO

SHPE 1195 - Braço do fecho gemiclo direito
SHPE 1196 - Braço do fecho gemiclo esquerdo

BUJÃO ILHÓS - ATLAS

SHPE 281 - Bujão ilhós
SHPE 282 - Chave para bujão ilhós

CABO ACIONADOR

SHPE 283 - Cabo acionador de rampa pequeno
SHPE 284 - Cabo acionador de rampa médio
SHPE 285 - Cabo acionador de rampa grande

CONJUNTO ABENCI



SHPE 286 - Conjunto abenci

CONJUNTO IENCI



SHPE 287 - Conjunto ienci

CABO DE COMANDO



SHPE 288 - 9 vias x 0,75mm²

SHPE 289 - 12 vias x 0,75mm²

SHPE 290 - 18 vias x 0,75mm²

CABO TRANSPORTADOR PORTA THYSSEN



SHPE 291 - Cabo transportador porta AL LU 700 com 1207mm

SHPE 292 - Cabo transportador de porta AL LU 800 com 1307 mm

SHPE 293 - Cabo transportador de porta AL LU 900 com 1407 mm

SHPE 294 - Cabo transportador de porta AL LU 1000 com 1507 mm

SHPE 295 - Cabo transportador de porta AL LU 1100 com 1607 mm

SHPE 296 - Cabo transportador de porta AL LU 1200 com 1707 mm

SHPE 297 - Cabo transportador AC LU 900 com 3682 mm

SHPE 298 - Cabo transportador AC LU 800 com 3282 mm

SHPE 299 - Cabo transportador AC LU 1100 com 4482 mm

CABO OPERADOR



SHPE 300 - Cabo operador de porta 5,4 m

SHPE 301 - Cabo operador de porta 6,4 m

CABO OPERADOR - THYSSEN



SHPE 302 - Cabo EV L800 Thyssen 3,3 m

SHPE 303 - Cabo EV L900 Thyssen 3,5 m

CAIXA DE PASSAGEM



SHPE 304 - Caixa de passagem com 54 bornes

SHPE 305 - Caixa de passagem com 72 bornes

CAIXA PLÁSTICA



SHPE 306 - Com 1 furo (L:68 x A:53 x C:68 mm)

SHPE 307 - Com 2 furos (L:68 x A:53 x C:106 mm)

SHPE 308 - Com 3 furos (L:68 x A:53 x C:136 mm)

SHPE 309 - Com 4 furos (L:68 x A:53 x C:166 mm)

CAIXA PLÁSTICA MONTADA



SHPE 310- Caixa plástica montada com botão de emergência

CAPACITOR



SHPE 311 - Capacitor operador selcom

CAIXA PLÁSTICA MONTADA

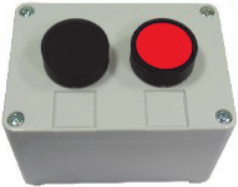

SHPE 312 - Caixa plástica montada com 2 botões pulsadores

CAIXA PLÁSTICA MONTADA



SHPE 313 - Caixa plástica montada com 3 botões pulsadores

CAIXA PLÁSTICA MONTADA

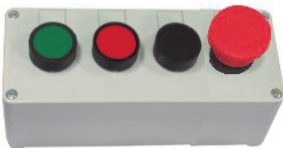

SHPE 314 - Caixa plástica montada com 3 botões pulsadores e 1 botão de emergência

CAIXA PLÁSTICA



SHPE 1197 - Caixa plástica botoeira e IPD tke 213 x 60 x 60mm

CALÇO - ATLAS



SHPE 315 - Calço para corredeira

CALÇO - SUR

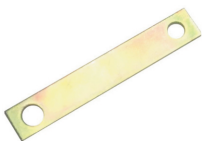

SHPE 316 - Calço para sapatilha

CARVÃO - ATLAS

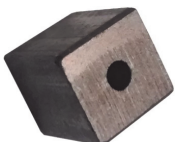

SHPE 317 - Carvão simples 16,1x16,1x19,05 mm

CARVÃO - ATLAS



SHPE 318 - Carvão duplo 16x19x34 cm

CARVÃO - ATLAS

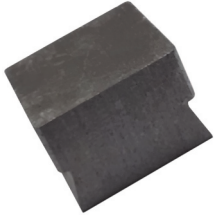

SHPE 319 - Carvão para quadro QV grande
SHPE 320 - Carvão para quadro QV pequeno

CARVÃO - OTIS



SHPE 321 - Carvão 10x10x23 mm para chave comutação 5 HP

CARVÃO - OTIS



SHPE 322 - Carvão 15x15x25 mm para chave comutação 10 HP

CARVÃO - REAL



SHPE 323 - Carvão simples 20x20x20 mm

CARVÃO - SUR



SHPE 324 - Carvão 17x19x28 mm

CARVÃO - SCHINDLER

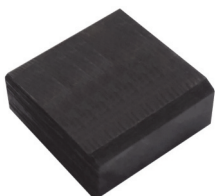

SHPE 325 - Carvão 10x20x20 mm para demarrador

CHAVE DE DESTRAVAR



SHPE 326 - Chave de emergência Thyssen

CHAVE DE DESTRAVAR



SHPE 327 - Chave triangular de destravar trinco

CHAVE DE DESTRAVAR



SHPE 328 - Chave de destravar triangular - 02

CHAVE DE DESTRAVAR



SHPE 329 - Chave de destravar trinco triangular longa 200 mm

CHAVE DE DESTRAVAR



SHPE 330 - Chave de destravar triangular

CHAVE DE DESTRAVAR - OTIS



SHPE 331 - Chave articulada de destravar trinco

CHAVE DE DESTRAVAR - OTIS



SHPE 332- Chave canoa de destravar trinco

CHAVE DE DESTRAVAR - OTIS



SHPE 333 - Chave triangular de destravar trinco

CHAVE DE DESTRAVAR - SCHINDLER



SHPE 334 - Chave baioneta de destravar trinco

CHAVE DE DESTRAVAR - SUR



SHPE 335 - Chave canoa de destravar trinco

CHAVE DE SEGURANÇA



SHPE 336 - CZ-93CPG03

- Chave de segurança
- 1 NA / 1 NF

SHPE 337 - CZ-93K3

- Acoplador plástico ajustável

CHAVE ELÉTRICA

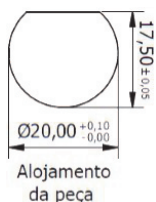

SHPE 338 - Liga/Desliga (A chave sai nas duas posições)

SHPE 339 - Liga/Desliga (A chave sai apenas em uma posição)

SHPE 340 - Liga/Desliga (Segredos iguais, a chave sai nas duas posições)

CHAVE SELETORA

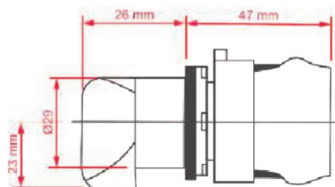

SHPE 341 - Chave seletora 2 posições

CHAVETA - OTIS



SHPE 342 - Chaveta para porta de pavimento AM 1400

CHAVETA - SUR



SHPE 343 - Para fechador piso

CHAVETA - SUR



SHPE 344 - Para fechador aéreo

CHAVETA - THYSSSEN



SHPE 345 - Kit chaveta Thyssen

CLIP PARA GUIA



SHPE 346 - Clip T1 (M10, 10 mm) guia T45/A, T50/A

SHPE 347 - Clip T2 (M12, 12 mm) guia T70-1/B, T75-3/B, T78/B, T82/B

SHPE 348 - Clip T3 (M14, 14 mm) guia T89/B, T90/B

SHPE 349 - Clip T4 (M16, 16 mm) guia T114/B, T127-1/B, T127-2/B

SHPE 350 - Clip T5 (M18, 18 mm) guia T140-1/B, T140-2/B

CLIP PARA GUIA

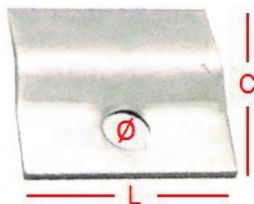

SHPE 351 - Clip para guia 2 mm (L:64xC:57xØ:15 mm)

SHPE 352 - Clip para guia 3 mm (L:38xC:44xØ:10 mm)

CLIP PARA TIRANTE



SHPE 353 - Para cabo 5/16"

SHPE 354 - Para cabo 3/8"

SHPE 355 - Para cabo 1/2"

SHPE 356 - Para cabo 5/8"

COLETOR DE ÓLEO



SHPE 357 - Coletor de óleo branco para 3 guias

COLETOR DE ÓLEO



SHPE 358 - Coletor de óleo azul para 4 guias

CONTATO- THYSSEN

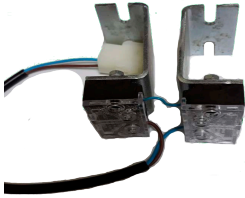

SHPE 359 - Contato GS central com ferragem

CONTATO



SHPE 360 - Contato para porta completo tipo Fermator

CONTATO



SHPE 361 - Contato GS 'igrejinha' para porta completo tipo Fermator

CONTATO - ATLAS



SHPE 362 - Para contato V externo
SHPE 363 - Para contato V interno

CONTATO - ATLAS



SHPE 364 - Contato AZ 06 A - Especial 184002

CONTATO - ATLAS



SHPE 365 - Contato meia lua para botão BL 60

CONTATO - ATLAS



SHPE 366 - Contato V para chave

CONTATO - THYSSEN



SHPE 367 - Contato AZ 05 com aba

CONTATO - KONE

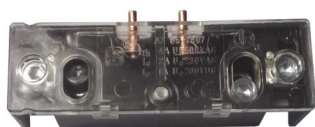

SHPE 368 - Contato AZ 05 sem aba 197592

CONTATO - THYSSEN



SHPE 369 - Contato de porta AZ 06 (fêmea) 184326

CONTATO - KONE



SHPE 370 - Contato de porta AZ 06 (macho)

CONTATO - KONE

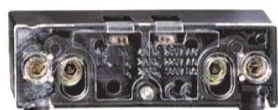

SHPE 371 - Contato de porta AZ 07 18404301

CONTATO - KONE

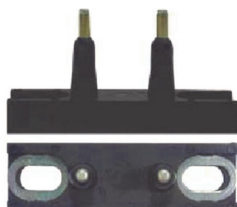

SHPE 372 - Ponte para contato AZ 06 e AZ-14 KDL 18814301

SHPE 373 - Ponte para contato AZ 07 197504

CONTATO - KONE

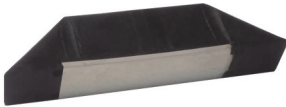

SHPE 374 - Ponte para contato AZ 05

CONTATO - THYSSEN

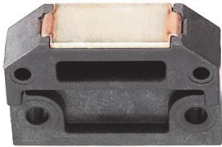

SHPE 375 - Ponte para contato de porta AZ 051 B 18891701

CONTATO - KONE

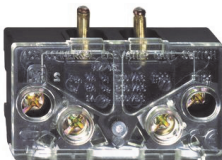

SHPE 376 - Contato de porta AZ 051 B 184254

CONTATO - OTIS



SHPE 377 - Contato para porta EV curto

CONTATO - OTIS



SHPE 378 - Contato ponte ADS para trinco modelinho

CONTATO - OTIS



SHPE 379 - Contato DS para trinco (FO9940B)

CONTATO - OTIS



SHPE 380 - Contato duplo para trinco EV - curto

CONTATO - OTIS



SHPE 381 - Contato para carrinho seletor pequeno
 SHPE 382 - Contato para carrinho seletor grande (foto)

CONTATO - OTIS



SHPE 383 - Contato FH

CONTATO - OTIS



SHPE 384 - Contato para carrinho seletor

CONTATO - THYSSEN



SHPE 385 - Contato BK

CONTATO - REAL



SHPE 386 - Contato L longo para chave de comutação

CONTATO - ATLAS

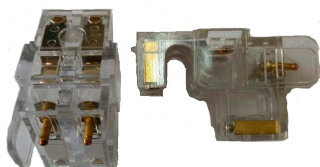

SHPE 387 - Miolo do trinco TV3

CONTATO - SCHINDLER



SHPE 388 - Contato KS com lâmina

CONTATO - SCHINDLER



SHPE 389- Ferragem para contato KS

CONTATO - SCHINDLER



SHPE 390 - Ponte para contato KS

CONTATO - SCHINDLER



SHPE 391 - Contato KV preto 4 contatos
SHPE 392 - Contato KV preto 8 contatos

CONTATO - SCHINDLER



SHPE 393 - Contato KV transparente com 8 contatos

CONTATO - SCHINDLER



SHPE 394 - Contato KTC móvel

CONTATO - SCHINDLER



SHPE 395 - Contato KTC fixo

CONTATO - SCHINDLER



SHPE 396 - Contato fixo para chave UA

CONTATO - SCHINDLER



SHPE 397 - Contato móvel para chave UA

CONTATO - SCHINDLER

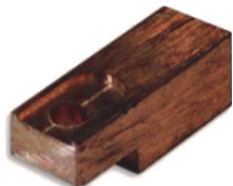

SHPE 398 - Contato fixo para demarrador

CONTATO - SCHMERSAL



SHPE 399 - Ponte para contato AZ 06 e AZ-14 KDL 18814301

SHPE 400 - Contato AZ 14 KDL 184281

CONTATO - SCHMERSAL



SHPE 401 - Contato AZ 15 Z VK M16 196436

SHPE 402 - Atuador para contato AZ 15 196333

CONTATO - SELCOM



SHPE 403 - Contato AZ 15 2 VK M16

CONTATO - SELCOM



SHPE 404 - Contato para porta completo

CONTADORES



SHPE 405 - Minicontador azul 7A AC-3 (18A/AC1) com 1 NA bobina 110V 60 Hz

SHPE 406 - Minicontador azul 7A AC-3 (18A/AC1) com 1 NF bobina 110V 60 Hz

CONTADORES



SHPE 407 - Minicontator azul 9A AC-3 (20A/AC1) com 1 NA bobina 110V 60 Hz

SHPE 408 - Minicontator azul 9A AC-3 (20A/AC1) com 1 NF bobina 110V 60 Hz

CONTADORES



SHPE 409 - Minicontator azul 12A AC-3 (22A/AC1) com 1 NA bobina 110V 60 Hz

SHPE 410 - Minicontator azul 12A AC-3 (22A/AC1) com 1 NF bobina 110V 60 Hz

CONTADORES



SHPE 411 - Minicontator azul 16A AC-3 (22A/AC1) com 1 NA bobina 110V 60 Hz

SHPE 412 - Minicontator azul 16A AC-3 (22A/AC1) com 1 NF bobina 110V 60 Hz

SHPE 413 - Minicontator azul 22A AC-3 (32A/AC1) com 1 NF bobina 110V 60 Hz

CONTADORES



SHPE 414 - Minicontator azul 7A AC-3 (18A/AC1) com 1 NA bobina 220V 60 Hz

SHPE 415 - Minicontator azul 7A AC-3 (18A/AC1) com 1 NF bobina 220V 60 Hz

CONTADORES



SHPE 416 - Minicontator azul 9A AC-3 (20A/AC1) com 1 NA bobina 220V 60 Hz

SHPE 417 - Minicontator azul 9A AC-3 (20A/AC1) com 1 NF bobina 220V 60 Hz

CONTADORES



SHPE 418 - Minicontator azul 12A AC-3 (22A/AC1) com 1 NA bobina 220V 60 Hz

SHPE 419 - Minicontator azul 12A AC-3 (22A/AC1) com 1 NF bobina 220V 60 Hz

CONTADORES



SHPE 420 - Minicontator azul 16A AC-3 (22A/AC1) com 1 NA bobina 220V 60 Hz

SHPE 421 - Minicontator azul 16A AC-3 (22A/AC1) com 1 NF bobina 220V 60 Hz

SHPE 422 - Minicontator azul 22A AC-3 (32A/AC1) com 1 NF bobina 220V 60 Hz

CONTADORES



- SHPE 423 - Relê de sobrecarga azul 0,28 - 0,4A para minicontator CW07
- SHPE 424 - Relê de sobrecarga azul 0,4 - 0,63A para minicontator CW07
- SHPE 425 - Relê de sobrecarga azul 0,56 - 0,8A para minicontator CW07

CONTADORES



- SHPE 426 - Relê de sobrecarga azul 0,8 - 1,2A para minicontator CW07
- SHPE 427 - Relê de sobrecarga azul 1,2 - 1,8A para minicontator CW07
- SHPE 428 - Relê de sobrecarga azul 1,8 - 2,8A para minicontator CW07

CONECTOR



- SHPE 442 - Conector hylok femea 2 alojamentos
- SHPE 443 - Conector hylok femea 3 alojamentos
- SHPE 444 - Conector hylok femea 4 alojamentos
- SHPE 445 - Conector hylok femea 6 alojamentos
- SHPE 446 - Conector hylok femea 9 alojamentos

CONECTOR



- SHPE 447 - Conector hylok femea 12 alojamentos

CONECTOR



- SHPE 436 - Conector hylok macho 2 alojamentos
- SHPE 437 - Conector hylok macho 3 alojamentos
- SHPE 438 - Conector hylok macho 4 alojamentos
- SHPE 439 - Conector hylok macho 6 alojamentos
- SHPE 440 - Conector hylok macho 9 alojamentos
- SHPE 441 - Conector hylok macho 12 alojamentos

CONECTOR



- SHPE 434 - Pino macho para conector hylok
- SHPE 435 - Pino femea para conector hylok

CORREDIÇA - OTIS



- SHPE 526 - Iserto de porta prima

CORREDIÇA - SUR



SHPE 527 - Corrediça sapatilha para porta - espiga (Par)

CORREDIÇA - THYSSEN



SHPE 528 - Corrediça de porta
SHPE 529 - Corrediça com pino excêntrico Thyssen 5/16"

CORREDIÇA - THYSSEN



SHPE 530 - Suporte para corrediça Thyssen

CORREDIÇA - THYSSEN

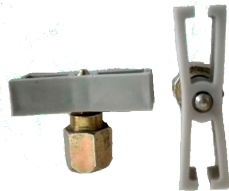

SHPE531 - Corrediça Padronizada tke M8 (13mm)
SHPE532 - Corrediça padronizada tke M10 (17mm)

CORREDIÇA



SHPE 448 - Corrediça de nylon para porta tipo Fermator

CORREDIÇA

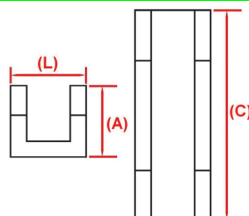
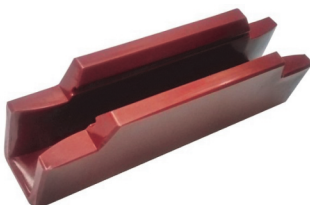

SHPE 449 - Corrediça (L:30xA:40xC:120) para suporte 10mm
SHPE 450 - Corrediça (L:30xA:40xC:120) para suporte 16mm

CORREDIÇA



SHPE 451 - Corredixa sur fuji com ferragem

CORREDIÇA - ATLAS

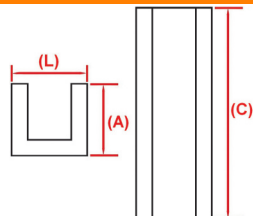

SHPE 452 - Para cabina com abas (L:33xA:23xC:117 mm)

CORREDIÇA - ATLAS

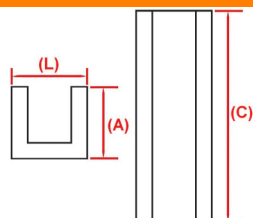
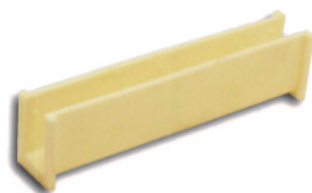

SHPE 453 - Para cabina com abas (L:21xA:33xC:149 mm)

CORREDIÇA - ATLAS

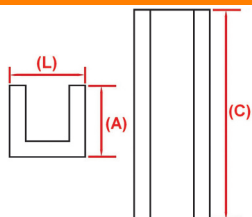

SHPE 454 - Para cabina com abas (L:21xA:33xC:198 mm)

CORREDIÇA - ATLAS

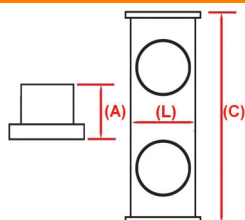
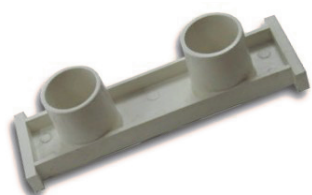

SHPE 455 - Central tipo binóculo (L:34xA:32xC:142 mm)

SHPE 456 - Central tipo binóculo (L:34xA:38xC:142 mm)

CORREDIÇA - ATLAS

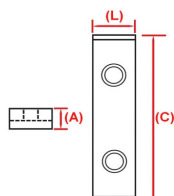

SHPE 457- Lateral tipo binóculo (L:28xA:18xC:145 mm)

SHPE 458 - Lateral tipo binóculo (L:17xA:23xC:140 mm)

CORREDIÇA - ATLAS



SHPE 459 - Borracha para corrediça binóculo

CORREDIÇA - ATLAS



SHPE 460 - Mola de compressão para corrediça binóculo

CORREDIÇA - KONE

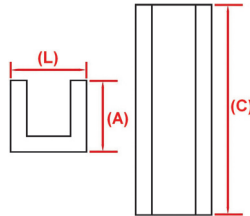
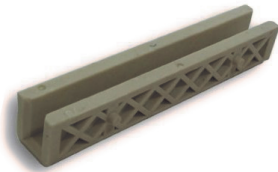

SHPE 461 - Nylon (L:27xA:29xC:173 mm) para guia 9mm
 SHPE 462 - Nylon (L:27xA:29xC:173 mm) para guia 11mm
 SHPE 463 - Nylon (L:27xA:29xC:173 mm) para guia 16mm

CORREDIÇA - OTIS

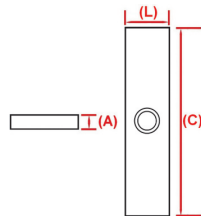
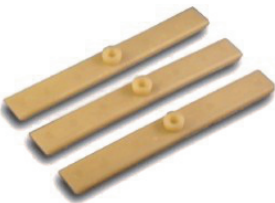

SHPE 464 - Para cabina e contrapeso (L:25xA:6xC:190 mm)

CORREDIÇA - OTIS



SHPE 465 - Corrediça Gen2 guia 10 mm

CORREDIÇA - OTIS



SHPE 466 - Corrediça GEN2 guia 16 mm

CORREDIÇA - SHINDLER

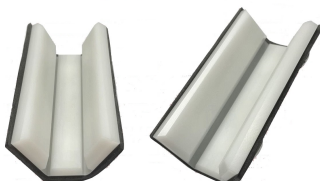

SHPE 467 - Corrediça S001 guia 10 mm
 SHPE 468 - Corrediça S001 guia 16 mm

CORREDIÇA - SCHINDLER

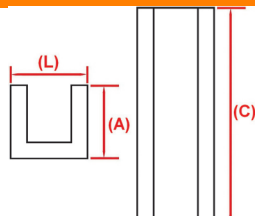
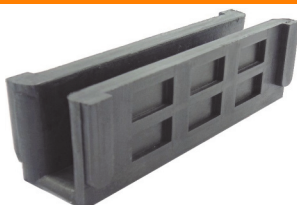

SHPE 469 - Cabina e contrapeso (L:25xA:38xC:120) guia 11 mm
 SHPE 470 - Cabina e contrapeso (L:25xA:38xC:120) guia 09 mm
 SHPE 471 - Cabina e contrapeso (L:25xA:38xC:120) guia 16 mm

CORREDIÇA - SCHINDLER

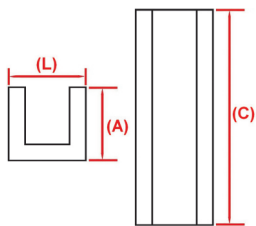

- SHPE 472 - Cabina e contrapeso (L:25xA:28xC:140) guia 16 mm
- SHPE 473 - Cabina e contrapeso (L:25xA:28xC:140) guia 11 mm
- SHPE 474 - Cabina e contrapeso (L:29xA:36xC:260) guia 09 mm
- SHPE 475 - Cabina e contrapeso (L:29xA:36xC:260) guia 10 mm
- SHPE 476 - Cabina e contrapeso (L:29xA:26xC:260) guia 11 mm
- SHPE 477 - Cabina e contrapeso (L:29xA:36xC:260) guia 16 mm
- SHPE 478 - Cabina e contrapeso (L:29xA:26xC:260) guia 09 mm

CORREDIÇA - SUR

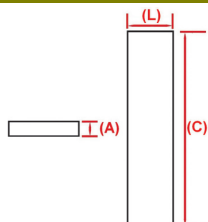

- SHPE 479 - Lateral de nylon (L:24xA:6xC:120 mm)
- SHPE 480 - Central de nylon (L:28xA:6xC:120 mm)
- SHPE 481 - Central de nylon (L:21xA:6xC:120 mm)

Conjunto formado com 3 peças (2 laterais + 1 central)

CORREDIÇA - THYSSEN



- SHPE 482 - Corrediça Synergy para guia 9 mm
- SHPE 483 - Corrediça Synergy para guia 16 mm

CORREDIÇA - THYSSEN

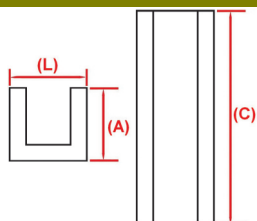

- SHPE 484 - Corrediça SL (L:26xA:30xC:200) para guia 9 mm

CORREDIÇA - THYSSEN

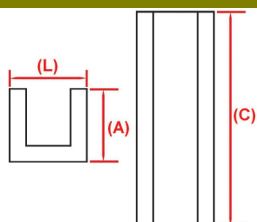
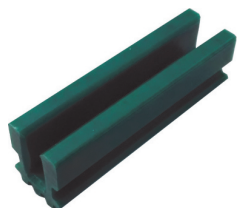

- SHPE 485 - Corrediça SL (L:26xA:30xC:100) para guia 9 mm

CORREDIÇA - THYSSEN

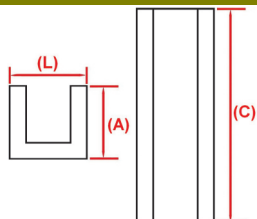
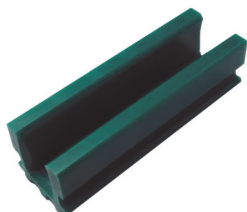

- SHPE 486 - Corrediça SL (L:33xA:30xC:100) para guia 16 mm

CORREDIÇA - THYSSEN

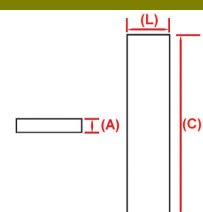
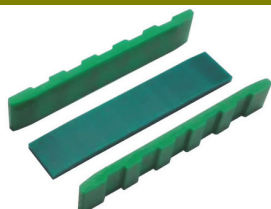

- SHPE 487 - Cabina - Central (L:21xA:6xC:120 mm)
- SHPE 488 - Cabina - Lateral (L:24xA:6xC:120 mm)
- SHPE 489 - Cabina - Central (L:28xA:6xC:120 mm)

Conjunto formado com 3 peças (2 laterais + 1 central)

CORREDIÇA - THYSSEN

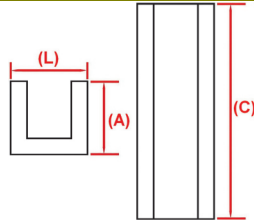

SHPE 490 - Corrediça cinza (L:33xA:32xC:98) para guia 16 mm
 SHPE491 - Corrediça cinza (L:26xA:32xC:98) para guia 9 mm
 SHPE1158 - Corrediça cinza (L:26x32xC:98) para guia de 6mm

Uso na cabine ou contra peso do elevador thyssen

CORREDIÇA DE PORTA



SHPE 492 - Pino com corrediça de borracha tipo Fermator
 SHPE 493 - Corrediça de borracha tipo Fermator

CORREDIÇA DE PORTA

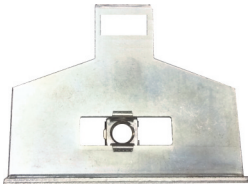

SHPE 494 - Suporte para corrediça tipo GMV

CORREDIÇA DE PORTA

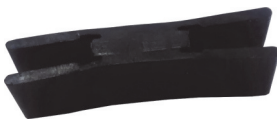

SHPE 495 - Corrediça de borracha tipo GMV

CORREDIÇA DE PORTA



SHPE 496 - Corrediça de porta tipo GMV completa

CORREDIÇA DE PORTA

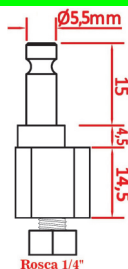

SHPE 497 - Pino excêntrico 1/4" 5,5mm

CORREDIÇA DE PORTA

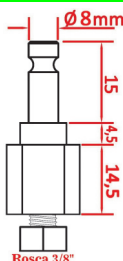

SHPE 498 - Pino concêntrico 3/8" 7mm

CORREDIÇA DE PORTA

SHPE 499 - Pino excêntrico 1/4" 8mm

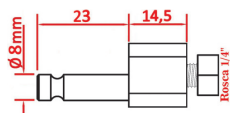

CORREDIÇA DE PORTA

SHPE 500 - Pino excêntrico 5/16" 8mm

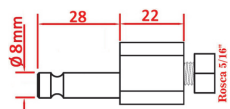

CORREDIÇA DE PORTA

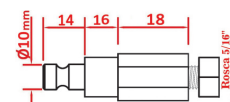
SHPE 501 - Pino concêntrico 5/16" para corrediça tipo
Fermator

CORREDIÇA DE PORTA

SHPE 502 - Pino concêntrico 5/16" 5,5 mm longo

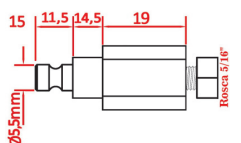

CORREDIÇA DE PORTA - ATLAS

SHPE 503 - Corrediça sapatilha para porta de cabina (Par)

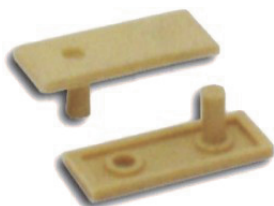

CORREDIÇA DE PORTA - ATLAS

SHPE 504 - Corrediça de nylon para porta de cabina 2000



CORREDIÇA DE PORTA - KONE

SHPE 505 - Corrediça para porta (Bujão grande)
SHPE 506 - Corrediça para porta (Bujão pequena)

CORREDIÇA DE PORTA - KONE



SHPE 507 - Corrediça curva para porta de cabine

CORREDIÇA DE PORTA - KONE



SHPE 508 - Corrediça direita para porta de cabine
SHPE 509 - Corrediça esquerda para porta de cabine

CORREDIÇA DE PORTA - KONE

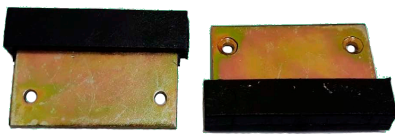

SHPE 1159 - Corrediça reta porta cabine Kone

CORREDIÇA DE PORTA - OTIS



SHPE 510 - Corrediça para porta de cabina (12x19x50 mm)

CORREDIÇA - OTIS

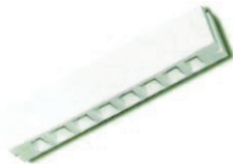

SHPE 511 - Corrediça para porta de cabina (12x19x89 mm)

CORREDIÇA DE PORTA - OTIS



SHPE 512 - Corrediça de feltro

CORREDIÇA DE PORTA - OTIS



SHPE 513 - Suporte para corrediça de porta alto

CORREDIÇA DE PORTA - OTIS



SHPE 514 - Suporte para corrediça de porta baixo

CORREDIÇA DE PORTA - SCHINDLER

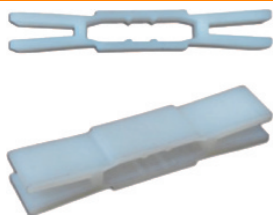

SHPE 515 - Corrediça de nylon para porta 11 mm
SHPE 516 - Corrediça de nylon para porta 14 mm

CORREDIÇA DE PORTA - SCHINDLER



SHPE 517 - Corrediça de nylon para porta miconic

CORREDIÇA DE PORTA - SCHINDLER



SHPE 518 - Corrediça para porta 14 mm (sapata)
SHPE 519 - Corrediça para porta 11 mm (sapata)

CORREDIÇA DE PORTA - SELCOM

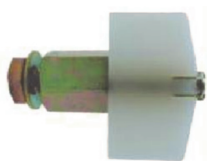

SHPE 520 - Corrediça para porta sem excêntrico
SHPE 521 - Corrediça para porta com excêntrico

Trabalha com o pino excêntrico 1/4" (SHPE 607)

CORREDIÇA DE PORTA - WITTUR



SHPE 522 - Suporte para corrediça

Trabalha com corrediça para porta com excêntrico (SHPE558)

CORREDIÇA DE PORTA - SELCOM

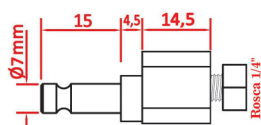

SHPE 523 - Pino excêntrico 1/4"

CORREDIÇA DE PORTA - SUR



SHPE 524 - Corrediça para soleira sem concêntrico

Trabalha com o pino concêntrico 3/8" (SHPE 607)

CORREDIÇA DE PORTA - SUR

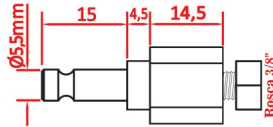

SHPE 525 - Pino concêntrico 3/8"

CORREIA - SCHINDLER



SHPE 538 - Correia para operador fina 4 ranhuras

CORREIA - SCHINDLER

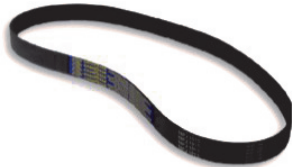

SHPE 539 - Correia para operador grossa 10 ranhuras

CORREIA - FERMATOR



SHPE 431 - Correia sincronizadora fermator

CORREIA - THYSSEN



SHPE 430 - Correia sincronizada TKE

CORREIA - SUR



SHPE 429 - Correia trapezoidal 6x4x735mm

CORREIA



SHPE 533 - Correia 450L tipo Fermator

CORREIA - ATLAS



SHPE 534 - Correia A31
SHPE 535 - Correia A39

CORREIA - KONE

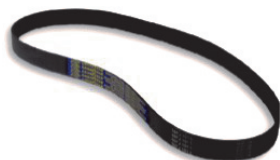

SHPE 536 - Correia para operador 10 ranhuras
SHPE 537 - Correia para operador 6 ranhuras

CINTA DE TRAÇÃO - OTIS



SHPE 433 - Cinta de tração GEN 2

Produto sob encomenda

CINTA DE TRAÇÃO - ATLAS



SHPE 432 - Elemento de tração S001

Produto sob encomenda

DISPLAY - SUR

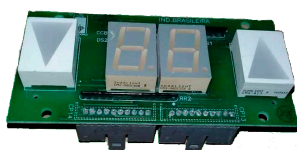

SHPE 540 - Display ST 99

DISPLAY - SUR

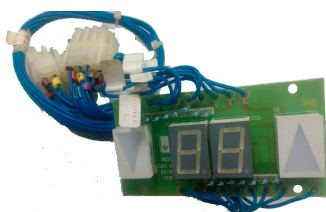

SHPE541- Display sur ST99 mcp3 e mcp5

DISPLAY - THYSSEN

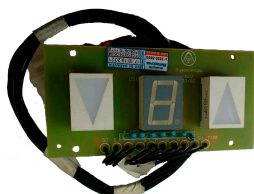

SHPE 542 - Display ST 99 1 dígito

DISPLAY ATLAS

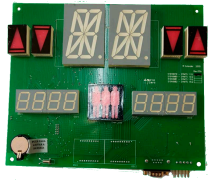

SHPE 543 - Display Atlas Excel

DISPLAY - OTIS

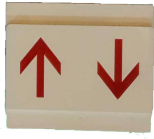

SHPE 544 - Display seta otis

DISPLAY - OTIS

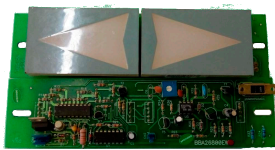

SHPE 1162 - Display seta cabine otis BBA26800EW2

DISPLAY - SCHINDLER

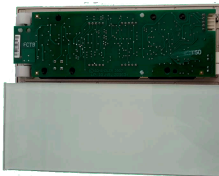

SHPE 545 - Display do S001 marco

DISPLAY - THYSSEN

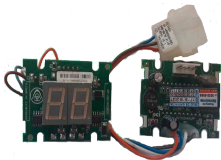

SHPE 546 - Display TK99 de botoeira

DISPLAY - THYSSEN

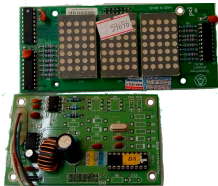

SHPE 547 - Display MTK PC plus cabina

DISPLAY - OTIS

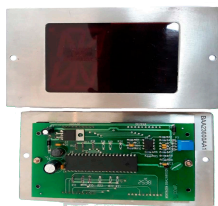

SHPE 548 - Display 1 digito com moldura

DISPLAY - THYSSEN

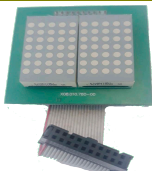

SHPE 549 - Display MTK 300

DISPLAY - THYSSEN

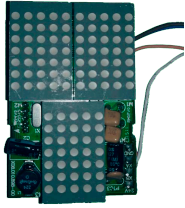

SHPE 550 - Display TK921 PB vermelho
SHPE 551 - Display TK921 PB azul

DISPLAY - SCANCHIP

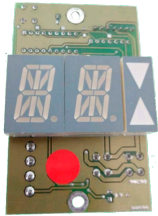

SHPE 552 - Display alfanumerico serial azul scanchip
SHPE 553 - Display alfanumerico serial vermelho scanchip

DISPLAY LCD UNIVERSAL

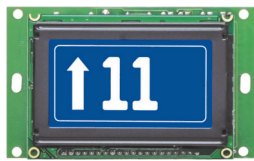

SHPE 554 - Display LCD monocromático 32 x 60 mm
SHPE 555 - Display LCD colorido TFT 5"

Este LCD trabalha independente do quadro de comando, utilizando kit decoder

DISCO DE FREIO

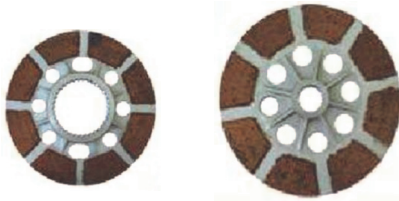

SHPE 556 - Disco de freio - FD32
SHPE 557 - Disco de freio - FD35

DITADOR - SCHINDLER

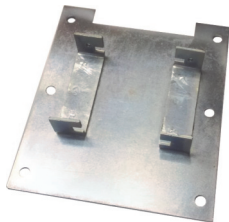

SHPE 558 - Base para dictador

DITADOR - SCHINDLER



SHPE 559 - Ditador aluminio

DITADOR - SCHINDLER



SHPE 560 - Ditador ferro

DITADOR - SCHINDLER



SHPE 561 - Roldana de borracha para ditador

DISTORCEDOR DE GUIA



SHPE 562 - Distorcedor

EIXO DO FREIO



SHPE 563 - Eixo da balaca freio EM 33

SHPE 564 - Eixo da balaca freio EM 25

ENCODER - OTIS



SHPE 1164- Encoder Gen2 TAA633H2

ENCODER - THYSSEN



SHPE 565 - Encoder endat 2048 pulsos

ENCODER - THYSSEN



SHPE 566 - Encode vazado D40 1024 pulsos

ENCODER



SHPE 567 - Encoder 1024 ppr com cabo de 10 metros

(eixo vazado Ø 12 mm)

ENCODER - ATLAS



SHPE 568 - Encoder 1000 pulsos

ENCODER - ATLAS



SHPE 1180- Acoplamento do Encoder atlas

ENCODER - OTIS



SHPE 1163- Encoder otis C50-Y-500BNF29/S533A

ENGRENAGEM - THYSSEN



SHPE 569 - Engrenagem do operador vvvf fase 3

ENGRENAGEM - FERMATOR



SHPE 570 - Engrenagem do operador vvvf fermator

ENGRENAGEM - THYSSEN

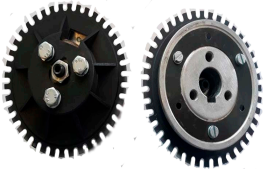

SHPE 571 - Engrenagem do contador de pulso do operador de portas

ENGRENAGEM - OTIS



SHPE 572 - Escova elétro grafite 16 x 32 x 44 mm

ENGRENAGEM - OTIS



SHPE 573 - Engrenagem meia lua operador 9550T

ENGRENAGEM- OTIS



SHPE 574 - Engrenagem carrinho seletor

ENGRENAGEM - OTIS



SHPE 575 - Engrenagem polia AT 120

FECHADURA TRIANGULAR



SHPE 576 - Fechadura triangular com mola

FECHADURA TRIANGULAR



SHPE 577 - Fechadura triangular sem mola

FECHO - OTIS



SHPE 578 - Fecho tipo Gemiclo completo direito (Foto)

SHPE 579 - Fecho tipo Gemiclo completo esquerdo

SHPE 580 - Braço para fechador Direito (Gemiclo)

SHPE 581 - Braço para fechador Esquerdo (Gemiclo)

FECHO - SUR

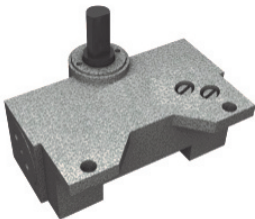

SHPE 582 - Fecho Sur aéreo - MD

SHPE 583 - Fecho Sur aéreo - ME (Foto)

FECHO - SUR



SHPE 584 - Fecho Sur piso - MD

SHPE 585 - Fecho Sur piso - ME (Foto)

FECHO AM 1400 ESPINGARDA



SHPE 586 - Fecho AM 1400 - MD - Espingarda (Foto)

SHPE 587 - Fecho AM 1400 - ME - Espingarda

FECHO COM IMÃ



SHPE 588 - Fecho com imã para porta

FECHOMATIC



SHPE 589 - Fechomatic MD (Foto)
SHPE 590 - Fechomatic ME

FECHOMATIC



SHPE 591 - Guia para fechomatic direito (Foto)
SHPE 592 - Guia para fechomatic esquerdo

FITA SELETORA - ATLAS



SHPE 593 - Fita seletora com furo lateral

Medida 0,4 x 25 mm Azulada

FITA SELETORA - ATLAS

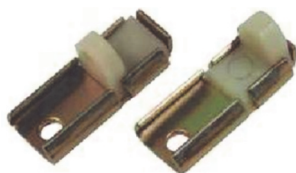

SHPE 594 - Cavalete central fita seletora
SHPE 595 - Cavalete lateral fita seletora

FITA SELETORA - ATLAS



SHPE 596 - Pino de latão para fita seletora grande
SHPE 597 - Pino de latão para fita seletora pequeno

FIXADOR DA CORREIA

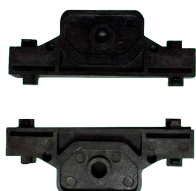

SHPE 598 - Fixador da correia AT120

FONTE REGUA OTIS

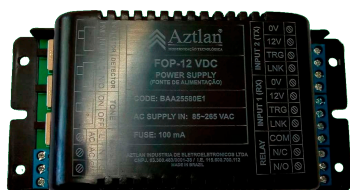

SHPE 1165 - Fonte de alimentação FOP-12VDC

FONTE ALIMENTAÇÃO



- SHPE 599 - Fonte Chaveada 24 volts 10 A
- SHPE 600 - Fonte Chaveada 24 Volts 15A
- SHPE 601 - Fonte Chaveada 24 Volts 5A
- SHPE 602 - Fonte chaveada 24 volts 1A

FONTE ALIMENTAÇÃO



- SHPE 603 - MFCH2 usada comando thyssen

FONTE ALIMENTAÇÃO



- SHPE 604 - MFINV usada no FDN com MCP5

FONTE - THYSSEN



- SHPE 605 - MFCH -Thyssen

FONTE - OTIS



- SHPE 606 - Fonte chaveada 34 vcc para elevador otis LCB2

FREIO BINDER



- SHPE 607 - Freio magnético blinder 200 mm
- SHPE 608 - Freio magnético binder 250 mm
- SHPE 609 - Sapata para freio magnético 200 mm
- SHPE 610 - Sapata para freio magnético 250 mm

FREIO MAGNÉTICO

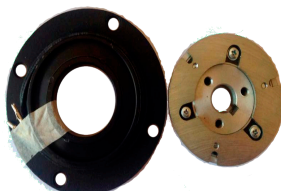

- SHPE 611 - Conjunto freio magnético operador vvvf

FREIO BINDER



SHPE 612 - Bobina freio magnético binder 200 mm
 SHPE 613 - Bobina freio magnético binder 250 mm

FREIO INSTANTÂNEO



SHPE 614 - Bloco para freio instantâneo guia 9 mm
 SHPE 615 - Bloco para freio instantâneo guia 11 mm
 SHPE 616 - Bloco para freio instantâneo guia 16 mm

Atende velocidade até 60 mpm (1m/s)

FREIO INSTANTÂNEO



SHPE 617 - Timoneira para entre guias 1000 a 1300 mm
 SHPE 618 - Timoneira para entre guias 1300 a 1600 mm
 SHPE 619 - Timoneira para entre guias 1600 a 2200 mm

Atende velocidade até 60 mpm (1m/s)

FREIO INSTANTÂNEO



SHPE 620 - Freio instantâneo para Home-Lift guia 10 mm
 SHPE 621 - Freio instantâneo para Home-Lift guia 16 mm

FREIO PROGRESSIVO



SHPE 622 - 1200 a 4000 kg - 0,25 a 2,5 m/s para guia 10 mm
 SHPE 623 - 1200 a 4000 kg - 0,25 a 2,5 m/s para guia 16 mm

FUSÍVEL DE VIDRO



SHPE 624 - Fusível de vidro 1A
 SHPE 625 - Fusível de vidro 3A
 SHPE 626 - Fusível de vidro 4A
 SHPE 627 - Fusível de vidro 5A
 SHPE 628 - Fusível de vidro 10A

GARFO DE BORRACHA



SHPE 629 - Garfo de poliuretano para porta simultânea

GAXETA DE FELTRO



SHPE 630- Gaxeta de feltro EM 33
SHPE 631 - Gaxeta de feltro EM 62
SHPE 632 - Gaxeta de feltro EM 71
SHPE 633 - Gaxeta de feltro EM 81

GUIA DO FECHO GEMICLO



SHPE 1194 - Guia para fecho gemiclo

GUIA DO FECHO FECHOMATIC



SHPE 591 - Guia para fechomatic direito (Foto)
SHPE 592 - Guia para fechomatic esquerdo

HASTE DE FREIO



SHPE 101 - Haste freio EM 33
SHPE 102 - Haste freio EM 25

IMÃ

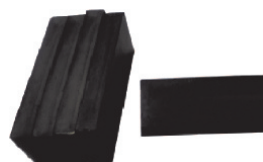

SHPE 634 - Imã flexível 50x20x7 mm

IMÃ



SHPE 635 - Imã flexível 150x15x7 mm

IMÃ



SHPE 636 - Imã flexível 300x15x7 mm

INTERCOMUNICADOR



SHPE 1166- Interfone Gen FBA 512 AC8 B-B

INTERCOMUNICADOR

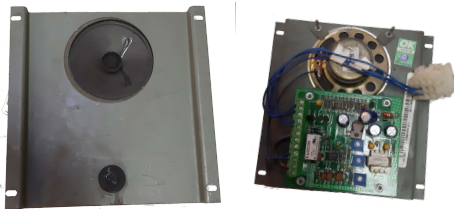

SHPE 1199 - Alta voz para intercomunicador TKE

INTERCOMUNICADOR



SHPE 637 - Viva voz Thevear

INTERCOMUNICADOR



SHPE 638- Central de intercomunicação CS-04T

Comunicação com até 4 elevadores

INTERCOMUNICADOR



SHPE 639 - Central de intercomunicação CS-04N

INTERCOMUNICADOR



SHPE 640 - Central de intercomunicação CS-10N

Comunicação com até 10 elevadores

INTERCOMUNICADOR



SHPE 641 - Central de intercomunicação AZ-C2

INTERCOMUNICADOR



SHPE 642 - Central de intercomunicação AZ-99

INTERCOMUNICADOR



SHPE 643 - Módulo viva-voz MVV-02

SHPE 644 - Módulo viva-voz AZ-MV

INTERCOMUNICADOR



SHPE 645 - Central viva-voz AZ-S2

Para utilização em elevador sem casa de máquina

INVERSOR - OTIS



SHPE 646 - Inversor dedicado otis

sob consulta

INVERSOR - YASKAWA



SHPE 647 - Inversor Yaskawa

Consulte potencia e tensão disponíveis

SHOPPING DOS ELEVADORES

INVERSOR - THYSSEN



SHPE 648 - Inversor de porta

INVERSOR DE PORTA



SHPE 649 - Inversor de porta AT 120

INVERSOR - FERMATOR



SHPE 650 - Inversor de porta VVVF4

INVERSOR - FERMATOR



SHPE 651 - Inversor de porta VVVF5

INVERSOR - THYSSEN



SHPE 652 - Inversor 21A FDO Thyssen

sob consulta

INVERSOR - THYSSEN



SHPE 653 - Unidade IGBT WEG

Consulte disponibilidade de potencia e tensão

INVERSOR - VARIODYN



SHPE 654 - Variodyn VF22BR

SHPE 655 - Variodin VF22BR (a base de troca)

IPD - KONE

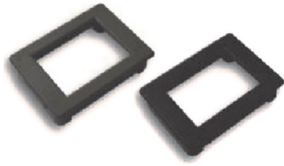

SHPE 656 - Corpo para IPD 14 mm preto
SHPE 657 - Corpo para IPD 14 mm cinza

IPD - KONE



SHPE 658 - Corpo para IPD 20 mm preto
SHPE 659 - Corpo para IPD 20 mm cinza

ISOLADOR - OTIS



SHPE 660 - Isolador LE IS ME Otis (BAA 429 AD2)
SHPE 661 - Isolador LE IS MA Otis (BAA 429 AD4)

LÂMINA - ATLAS



SHPE 662 - Para quadro QV

LÂMINA - ATLAS



SHPE 663 - Para chave de comutação fina 3/32"
SHPE 664 - Para chave de comutação grossa 1/8"

LÂMINA - OTIS



SHPE 665 - Para chave de comutação 5 HP

LÂMINA - OTIS



SHPE 666 - Para chave de comutação 10 HP

LÂMINA - REAL



SHPE 667 - Para chave de comutação simples 10 HP

LÂMINA - REAL

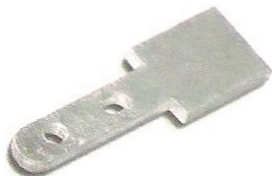

SHPE 668 - Para chave de comutação dupla 15 HP

LÂMINA - SUR



SHPE 669 - Para chave de comutação 10 HP

LÂMINA - SUR



SHPE 670 - Para chave grande

LÂMINA - SUR



SHPE 671 - Para chave pequena

LÂMPADA BAIONETA



SHPE 672 - Lâmpada baioneta 6V x 3W
 SHPE 673 - Lâmpada baioneta 12V x 3W
 SHPE 674 - Lâmpada baioneta 14V x 3W
 SHPE 675 - Lâmpada baioneta 24V x 3W
 SHPE 676 - Lâmpada baioneta 60V x 3W
 SHPE 677 - Lâmpada baioneta 13V x 3W

LÂMPADA LED



SHPE 678 - Lâmpada LED com pino
 SHPE 679 - Lâmpada LED com rabicho

LÂMPADA ROSCA



- SHPE 680 - Lâmpada rosca 6V x 3W
- SHPE 681 - Lâmpada rosca 12V x 3W
- SHPE 682 - Lâmpada rosca 14V x 3W
- SHPE 683 - Lâmpada rosca 24V x 3W
- SHPE 684 - Lâmpada rosca 220V x 3W

LIMITADOR DE VELOCIDADE

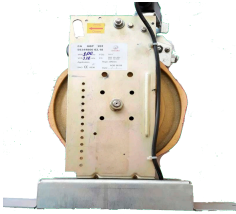

- SHPE 685 - Limitador de velocidade GBP 201 VKN 1,25
- SHPE 686 - Limitador de velocidade GBP 201 VKN 1,50
- SHPE 687 - Limitador de velocidade GBP 201 VKN 1,75

LIMITADOR DE VELOCIDADE



- SHPE 688 - Limitador de velocidade GBP 201 VKN 1,00
- SHPE 689 - Limitador de velocidade GBP 201 VKN 0,75

LIMITADOR DE VELOCIDADE

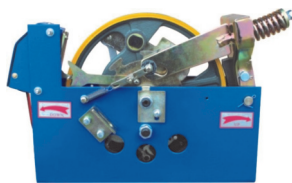

Para cabo de 1/4"

- SHPE 690 - Limitador de velocidade - 30 mpm
- SHPE 691 - Limitador de velocidade - 45 mpm
- SHPE 692 - Limitador de velocidade - 60 mpm
- SHPE 693 - Limitador de velocidade - 75 mpm
- SHPE 694 - Limitador de velocidade - 90 mpm
- SHPE 695 - Limitador de velocidade - 105 mpm
- SHPE 696 - Limitador de velocidade - 120 mpm

LIMITADOR DE VELOCIDADE



- SHPE 697 - Polia tensora 240 mm

Para cabo de 1/4"

LIMITE CTA

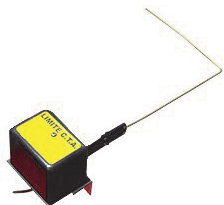

- SHPE 698 - Limite para cabos de tração alongados

LIMITE EOG - SCHINDLER



- SHPE 699 - Limite EOG eixo bala

LIMITE EOG - SCHINDLER



SHPE 700 - Limite EOG com mola TS

LIMITE EOG - SCHINDLER

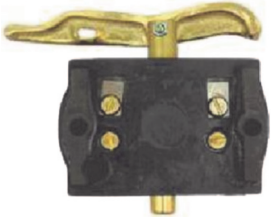

SHPE 701 - Limite EOG eixo KT com rampa

LIMITE FIM DE CURSO

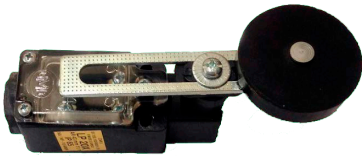

SHPE 702 - Limite LP 20X 1NA 1NF

LIMITE FIM DE CURSO



SHPE 703 - Chave limite TS 256-11z usado no BK freio duplo TKE

LIMITE FIM DE CURSO

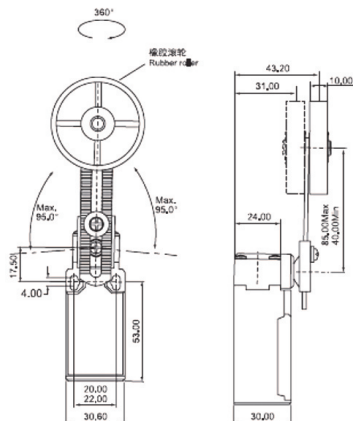

SHPE 704 - CLS-191

- Corpo plástico
- Haste ajustável
- Roldana de borracha Ø 50 mm

Temos este limite com cabo 1,5

LIMITE FIM DE CURSO

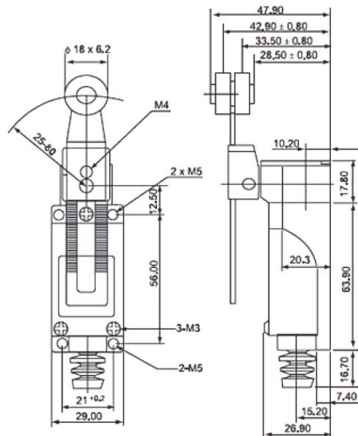

SHPE705 - TZ 8108

- Corpo metálico
- Haste ajustável
- Roldana de plástico Ø 18 mm

LIMITE FIM DE CURSO

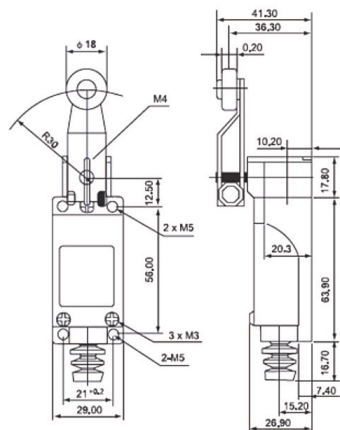

SHPE 706 - TZ 8104

- Corpo metálico
- Haste não ajustável
- Roldana de plástico Ø 18 mm

LIMITE FIM DE CURSO

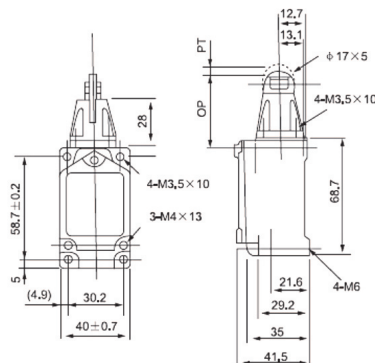

SHPE 707 - CWLD1

- Corpo metálico
- Roldana metálica Ø 17 mm

LIMITE FIM DE CURSO

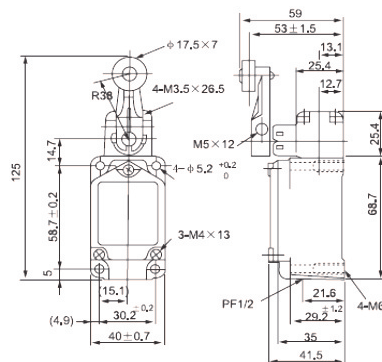

SHPE 708 - CWLCA 2-2

- Corpo metálico
- Haste não ajustável
- Roldana metálica Ø 17,5 mm

LIMITE FIM DE CURSO

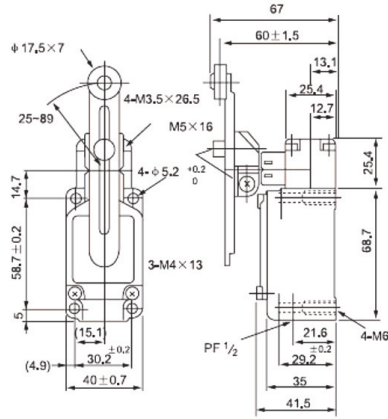

SHPE 709 - CWLCA 12-2Q

- Corpo metálico
- Haste ajustável
- Roldana metálica Ø 17,5 mm

LIMITE FIM DE CURSO

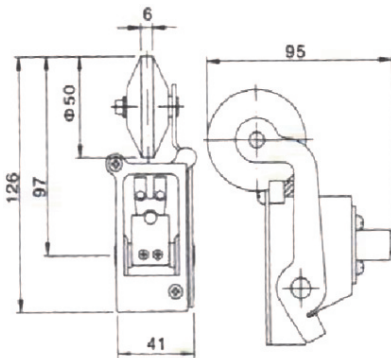

SHPE 710 - Limite switch NF

- Corpo plástico
- Roldana de borracha Ø 50 mm

LIMITE FIM DE CURSO

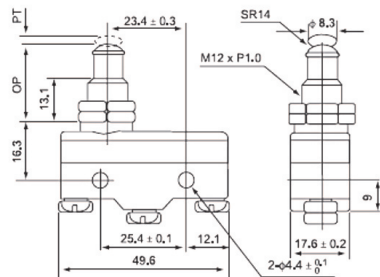

SHPE 711 - CM 1307

- Limite de pressão

LIMITE FIM DE CURSO

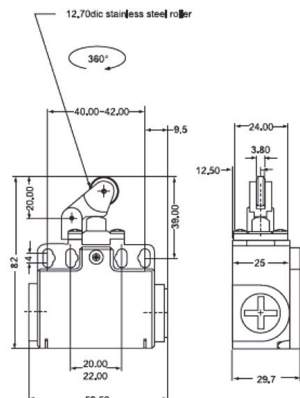

SHPE 712 - CLS 311

- Limite de pressão
- Corpo plástico
- Roldana metálica

LIMITE FIM DE CURSO

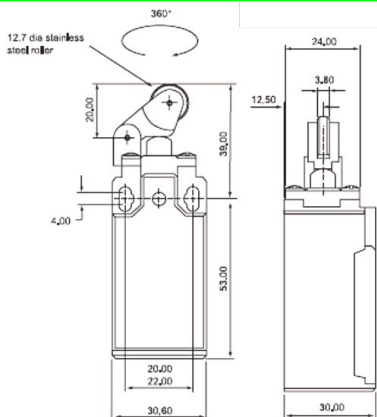

SHPE 713 - CLS 111

- Limite de pressão
- Corpo plástico
- Roldana metálica

LIMITE FIM DE CURSO

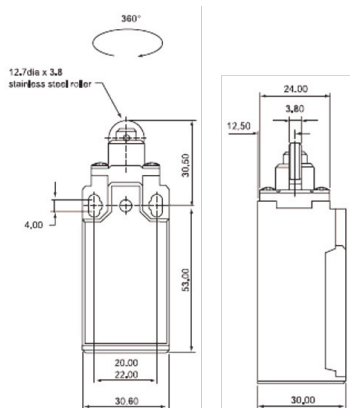

SHPE 714 - CLS 103R

- Limite de pressão com trava
- Corpo plástico
- Roldana metálica

LIMITE FIM DE CURSO

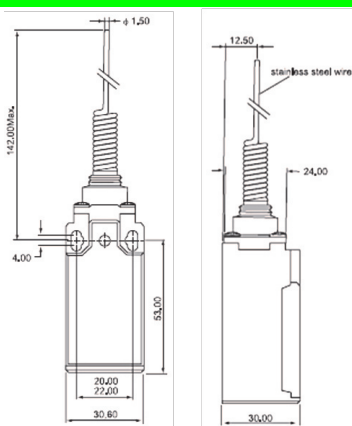

SHPE 715 - CLS 161

- Limite antena 100 mm
- Corpo plástico

LIMITE FIM DE CURSO - KONE

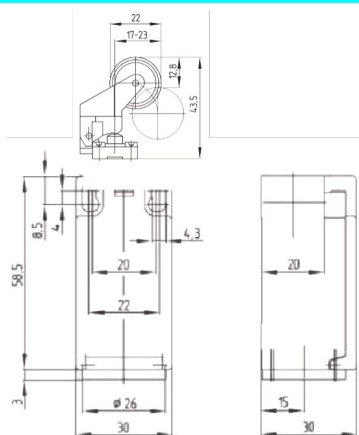

SHPE 716 - Limite ZK4 236 11ZP 18843002

SHOPPING DOS ELEVADORES

LIMITE FIM DE CURSO - REAL

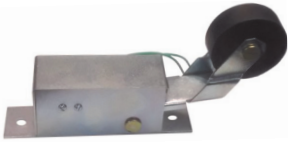

SHPE 717- Duplo NA/NF (foto)
SHPE 718- Simples NA
SHPE 719- Simples NF

LIMITE FIM DE CURSO - SCHMERSAL



SHPE 720 - TV22H 236 11Z 18823001

LIMITE FIM DE CURSO - SCHMERSAL



SHPE 721 - Z4V7HB 336 11Z 197184

LIMITE FIM DE CURSO - SCHMERSAL



SHPE 722 - TV1H 236 11Z 18836702

LIMITE FIM DE CURSO - SCHMERSAL

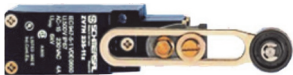

SHPE 723 - ZV7H 236 11Z 18843202

LIMITE FIM DE CURSO - SCHMERSAL

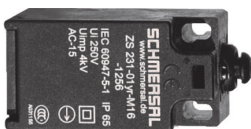

SHPE 724 - ZS 231 01 YR 18822601 usado como contato do limitador e polia tensora TKE

LIMITE FIM DE CURSO



SHPE 1193 - Contato do pistão UKS GB 14048.5



LIMITE FIM DE CURSO - SCHMERSAL

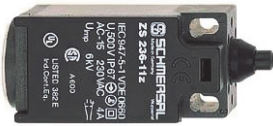

SHPE 725 - ZS 236 11ZR 197654

LIMITE FIM DE CURSO - SCHMERSAL

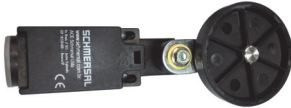

SHPE 726 - Limite TV 21H 236-11Z 18822801

LIMITE FIM DE CURSO - SCHMERSAL



SHPE 727 - Limite TV 14H 236 11ZP 196753

LIMITE FIM DE CURSO - SCHMERSAL



SHPE 728 - Limite TR 236 11Z 18841901

LIMITE FIM DE CURSO - SCHMERSAL



SHPE 729 - Limite M1S 660 11KY 194002

LIMITE FIM DE CURSO - SCHMERSAL



SHPE 730 - Limite Z4VHB 336-11Z 196134

LIMITE JACARÉ - ATLAS

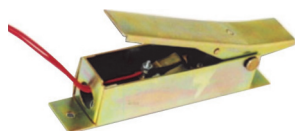

SHPE 731 - Contato aberto
SHPE 732 - Contato fechado

LIMITE - SUR



SHPE 733 - Limite de porta

LIMITE



SHPE 734 - Limite LM LPP

LIMITE



SHPE 735 - Limite ZS 336-11Z

LONA DE FREIO



SHPE 736 - Lona de freio 1/4" x 5"
SHPE 737 - Lona de freio 3/16" x 3"
SHPE 738 - Lona de freio 3/16" x 4"
SHPE 739 - Lona de freio 3/16" x 5"

LONA DE FREIO



SHPE 740 - Lona de freio 1/4" x 3"
SHPE 741 - Lona de freio 1/4" x 4"
SHPE 742 - Lona de freio 5/16" x 4"
SHPE 743 - Lona de freio 5/16" x 5"

LUBRIFICADOR DE GUIA



SHPE 744 - Lubrificador de guia ajustável

LUBRIFICADOR DE GUIA



SHPE 745 - Conjunto lubrificador de guia

LUBRIFICADOR DE GUIA



SHPE 746 - Conjunto lubrificador de guia

LUBRIFICADOR DE GUIA



SHPE 747 - Conjunto lubrificador de guia

LUBRIFICADOR DE GUIA



SHPE 748 - Conjunto lubrificador de guia

LUMINÁRIA - THYSSEN

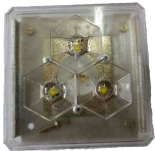

SHPE 749 - Luminária LED completa tke

LUMINÁRIA - THYSSEN



SHPE 1200 - Luminária LED redonda TKE

LUZ DE EMERGÊNCIA



SHPE 750 - Módulo de emergência MAE 06/12 VDC

LUZ DE EMERGÊNCIA



SHPE 751 - Kit lâmpada LED 06/30 VDC

LUZ DE EMERGÊNCIA



SHPE 752 - Luz de emergência com 3 LED's

LUZ DE EMERGÊNCIA

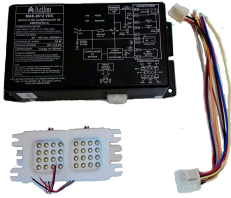

SHPE 1167 - Kit luz de emergência MAE 06/12 VDC

LUZ DE EMERGÊNCIA



SHPE 753 - Módulo bateria externa

LUZ DE EMERGÊNCIA



SHPE 754 - Carregador de bateria MAE-12 VDC

LUZ DE EMERGÊNCIA

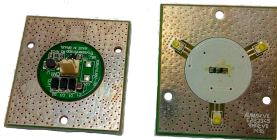

SHPE 755 - Modulo MLL2

Usado nas luminárias LEDs thyssenkrupp

LUZ DE CABINE - THYSSEN



SHPE756 - Conjunto LLC

MOTOR AT 120



SHPE 757 - Motor operador AT 120 direito

SHPE 758 - Motor operador AT 120 esquerdo

MOTOR WITTUR



SHPE 759 - Motor operador midi hidra (correia larga).

SHPE 760 - Motor operador midi supra

MICRO SWITCH

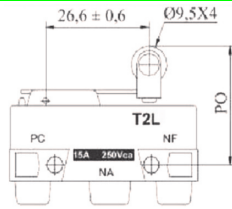

SHPE 761 - Micro Switch T2L

MICRO SWITCH

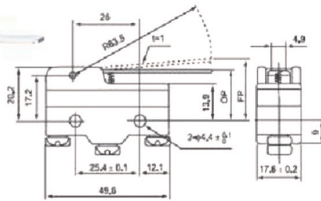

SHPE 762- CM-1701

- Chave micro switch
- Haste longa
- Sem roldana

MICRO SWITCH

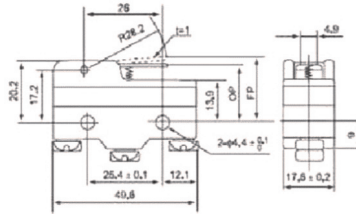

SHPE 763 - CM-1702

- Chave micro switch
- Haste curta
- Sem roldana

MICRO SWITCH

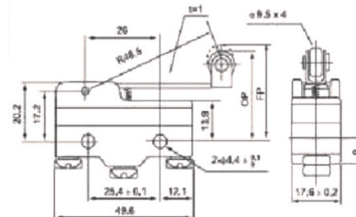
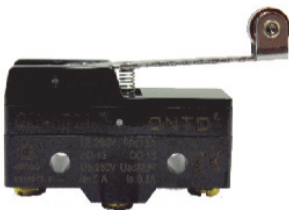

SHPE 764 - CM-1703

- Chave micro switch
- Haste longa
- Roldana metálica Ø 9,5 mm

MICRO SWITCH

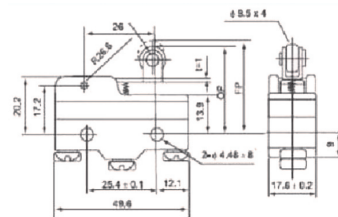

SHPE 765 - CM-1704

- Chave micro switch
- Haste curta
- Roldana metálica Ø 9,5 mm

MICRO SWITCH - SCHINDLER



SHPE 766 - Micro switch para botão MX

MIOLO DE TRINCO - ATLAS



SHPE 767 - Miolo de trinco EV com contato elétrico

MIOLO DE TRINCO - REAL



SHPE 768 - Para trinco de chapa (porta)

MIOLO DE TRINCO - REAL



SHPE 769 - Para trinco de chapa (trinco)

MOLA AÉREA



SHPE 770 - Mola aérea CR70

Substitui o dictador

MOLA AÉREA



SHPE 771 - Mola aérea de embutir (Sem braço)

MOLA AÉREA



SHPE 772 - Braço para mola aérea de embutir

MOLA AÉREA



SHPE 773 - Mola aérea completa

MOLA AÉREA



SHPE 774 - Mola dorma MA/200 (Força 4)

MOLA AÉREA

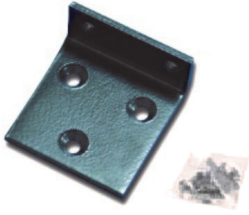

SHPE 775 - Cantoneira para alavanca

MOLA AÉREA

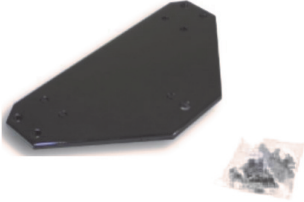

SHPE 776 - Chapa base para fechador

MOLA AÉREA

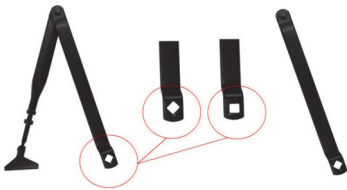

SHPE 777 - Braço 45° para fechador
SHPE 778 - Base para braço 45° para fechador
SHPE 779 - Braço 90° para fechador

MOLA MECÂNICA



SHPE 780 - Mola para tirante 5/16"

MOLA MECÂNICA



SHPE 781 - Mola para tirante 3/8"

MOLA MECÂNICA



SHPE 782 - Mola para tirante 1/2"

MOLA MECÂNICA



SHPE 783 - Mola para porta tipo Fermator 300mm
SHPE 784 - Mola para porta tipo Fermator 380mm
SHPE 785 - Mola para porta tipo Fermator 450mm

MOLA MECÂNICA - ATLAS

SHPE 786 - Mola grande para freio

MOLA MECÂNICA - ATLAS

SHPE 787 - Mola para botão classe A

MOLA MECÂNICA - THYSSEN

SHPE 788 - Mola para porta Thyssen Ø 14x640 mm

MOLA MECÂNICA - ATLAS

SHPE 789 - Mola para pick-up

MOLA MECÂNICA - ATLAS

SHPE 790 - Mola TS

MOLA MECÂNICA - SCHINDLER

SHPE 791 - Mola TS com corrente

MOLA MECÂNICA - OTIS

SHPE 792 - Mola para limitador de velocidade

MOLA MECÂNICA - OTIS



SHPE 793 - Mola para porta Otis esquerda
SHPE 794 - Mola para porta Otis direita (foto)

MOLA MECÂNICA - SCHINDLER



SHPE 795 - Mola para porta direita (foto)
SHPE 796 - Mola para porta esquerda

MOLA MECÂNICA - SCHINDLER



SHPE 797 - Mola para pick-up

MOLA MECÂNICA



SHPE 798 - Mola para fechamento de porta tipo
Selcom 20x735mm

MOTOR OPERADOR

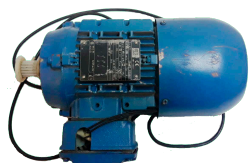

SHPE 1198 - Motor operador VVVF fase III com freio

NIVELADOR DO ÓLEO



SHPE 799 - Schindler W140
SHPE 800 - Schindler W163
SHPE 801 - Otis 11 BT
SHPE 802 - Otis 13 BT / 16 BT

ÓLEO LUBRIFICANTE



SHPE 803 - Óleo 2 mancais e buchas de motores e geradores
SHPE 804 - Óleo 1000 caixa de redução máquinas atlas 147/247
SHPE 805 - Óleo 1500 caixa de redução máquina real
SHPE 806 - Óleo 31 guias com patins de deslize

ÓLEO LUBRIFICANTE



SHPE 807 - Óleo 33 máquinas com engrenagem
SHPE 808 - Óleo 680 caixa de redução Otis
SHPE 809 - Óleo sintético 45 caixa de redução de elevadores
SHPE 810 - Óleo N° 60 (Cabo de tração)

PAINEL DE INCÊNDIO



SHPE 811 - Painel de incêndio com martelo (bombeiro)

PASTILHA BRAILLE

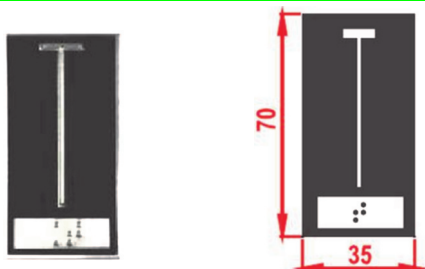

SHPE 812 - Pastilha braille para batente de porta

Temos todas as nomenclaturas exigidas pela norma

PASTILHA BRAILLE

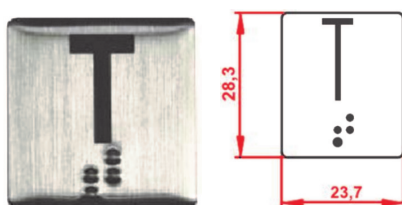

SHPE 813 - Pastilha braille em aço inox 23,7x28,3 mm

Temos todas as nomenclaturas exigidas pela norma

PLACA - ATLAS



SHPE 814 - Placa SDIC

PLACA - THYSEN

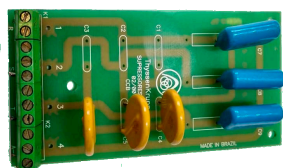

SHPE 815 - Placa de supressores

PLACA - ATLAS



SHPE 816 - Placa SMIC

PLACA - ATLAS

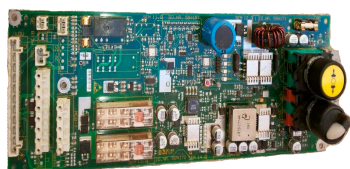

SHPE 817 - Placa de resgate SEM

PLACA SCANCHIP

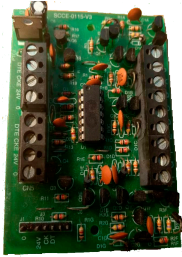

SHPE 818 - Placa RS 1 cabine scanchip

PLACA SCANCHIP



SHPE 819 - Placa RS 1 pavimento scanchip

PLACA DAIKEN

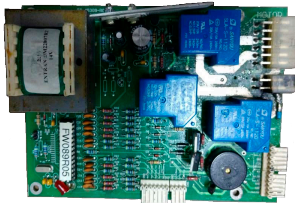

SHPE 820 - Placa da plataforma Daiken de fuso

PLACA SCANCHIP

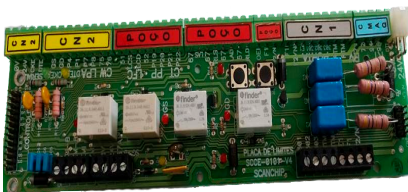

SHPE 821 - Placa de limites scanchip

PLACA SCANCHIP



SHPE 822 - Placa interface VVVF scanchip

PLACA SCANCHIP

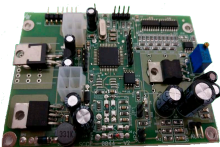

SHPE 823 - Placa voice scanchip

PLACA SCANCHIP

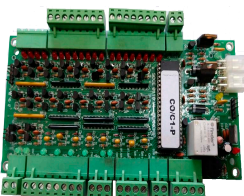

SHPE 824 - Placa serial 2 cabine scanchip

PESADOR DE CARGA

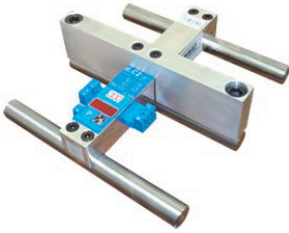

SHPE 825 - Pesador de carga sob consulta

PLACA - THYSSEN

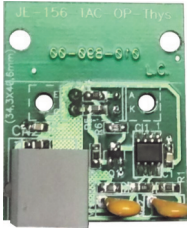

SHPE 826- Placa taco operador de porta Tacen1
 SHPE 827 - Placa taco operador de porta Tacen1 com rabicho

PLACA - SUR



SHPE 828 - Placa FLE-1 110 volts 3x.0591.PE.1
 SHPE 829 - Placa FLE-1 220 volts 3x.0591.PE.2
 SHPE 830 - Placa FLE-1 220 volts 3x.0591.PE.4

PLACA - SUR

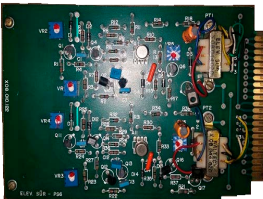

SHPE 831 - Placa PS-6D

PLACA - SUR

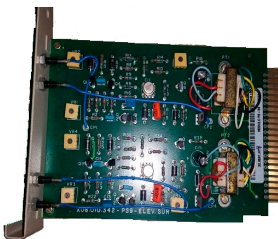

SHPE832 - Placa PS-9D

PLACA - SUR

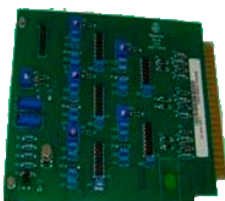

SHPE 833 - Placa PS8

PLACA - SUR



SHPE 834 - Placa LA-2

PLACA - SUR



SHPE 835 - Placa CL-1

PLACA OPERADOR WITTUR

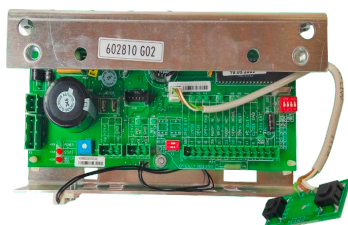

SHPE 836 - Placa midi supra

PLACA - ELETEM

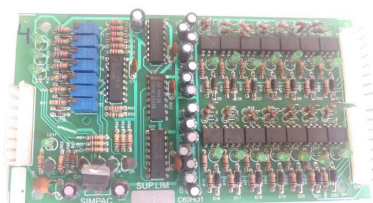

SHPE 837 - Placa suplim

PLACA - OTIS

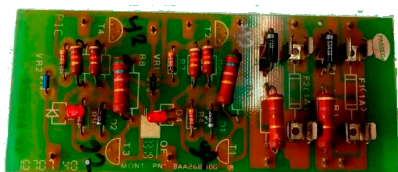

SHPE 838 - Placa PIC

PLACA SCHMERSAL



SHPE 839 - Placa Roteador

PLACA SCHMERSAL

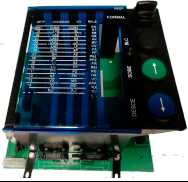

SHPE 840 - Rack de placas

PLACA SCHMERSAL



SHPE 841 - Placa TXRX

PLACA SCHMERSAL



SHPE 842 - Placa 3TxRx

PLACA SCHMERSAL



SHPE 843 - Placa de chamada

PLACA SCHMERSAL



SHPE 844 - Placa CPU

PLACA - ATLAS

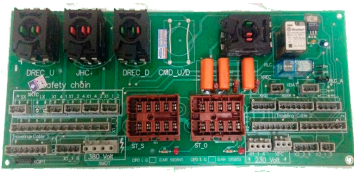

SHPE 845 - Placa eletrônica CIPD 1.Q

PLACA - SCANCHIP



SHPE 846 - Placa Scanchip serial

PLACA - SCANCHIP

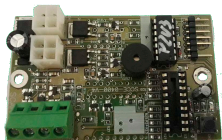

SHPE 1169 - Placa serial pavimento normatizada IPD vermelho SCCE0400-V4

PLACA - ATLAS

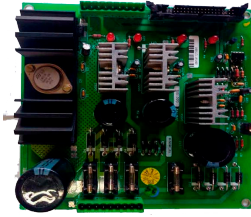

SHPE 847 - Placa fonte JVO 142

PLACA - ATLAS

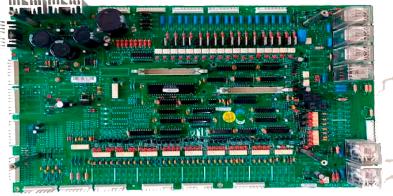

SHPE 848 - Placa I/O JVO 151

PLACA - ATLAS

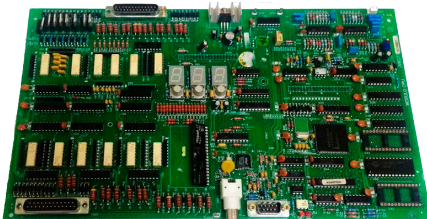

SHPE 849 - Placa CPU JVO 271

PLACA - SCHINDLER



SHPE 850 - Placa KFEB

PLACA - SCHINDLER



SHPE 851 - Placa PG 268 Q

PLACA - SCHINDLER



SHPE 852 - Placa ICOM miconic Lx

PLACA - THYSSEN



SHPE 853 - Placa MCP7S

PLACA - THYSSEN

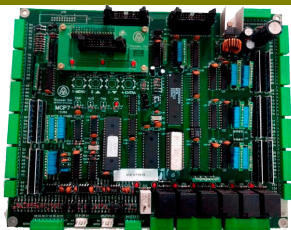

SHPE 854 - Placa MCP7 comum

PLACA - THYSSEN

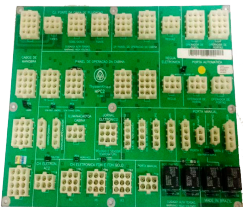

SHPE 855 - Placa de plugação MPC1

PLACA - THYSSEN

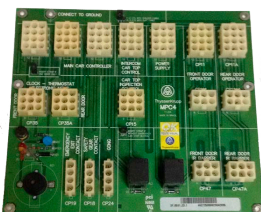

SHPE 856 - Placa de plugação MPC2
 SHPE 857 - Placa de plugação MPC4
 SHPE 858 - Placa de plugação MPC4L

PLACA - THYSSEN

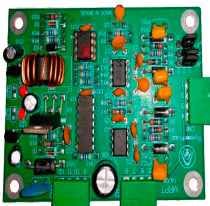

SHPE 859 - Placa MRPT do quadro

PLACA - OTIS

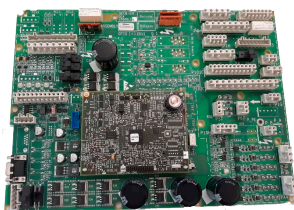

SHPE 860 - Placa GECB GEN

PLACA - THYSSEN



SHPE 861 - Placa MCC3 comum

PLACA - THYSSEN



SHPE 862 - Placa MCC3S

PLACA - THYSSEN

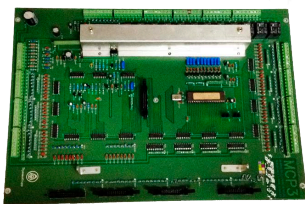

SHPE 863 - Placa MCP3

PLACA - THYSSEN

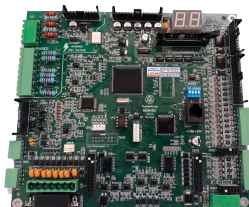

SHPE 864 - Placa eletrônica MCINV6

PLACA ELETRÔNICA

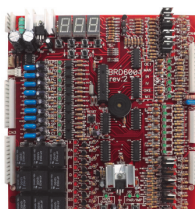

SHPE 865 - Placa MCP Eitem

Compatível com a placa Eitem PLA 6001

PLACA ELETRÔNICA



SHPE 866 - Placa PROTE 220V
SHPE 867 - Placa PROTE 380 V

Compatível com as placas Eitem PLA 6002 e 6003

PLACA ELETRÔNICA

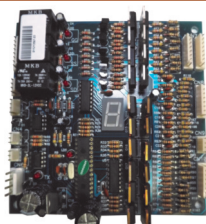

SHPE 868 - Placa GMUX

Compatível com a placa Eitem PLA 6004

PLACA ELETRÔNICA

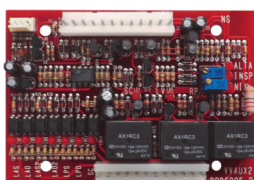

SHPE 869 - Placa VV AUX

Compatível com a placa Eitem PLA 6005

PLACA ELETRÔNICA

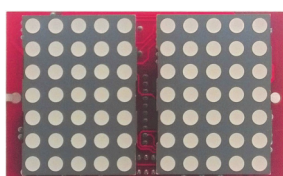

SHPE 870 - Placa Display 50 mm

Compatível com a placa Eitem PLA 7012

PLACA ELETRÔNICA

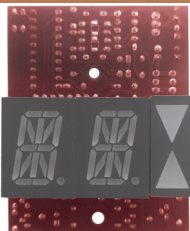

SHPE 871 - Placa Display 20 mm

Compatível com a placa Eletem PLA 8004

PLACA ELETRÔNICA



SHPE 872 - Placa fonte chaveada

Compatível com a placa Eletem PLA 8053

PLACA ELETRÔNICA



SHPE 873 - Placa CONV

Compatível com a placa Eletem PLA 8071

PLACA ELETRÔNICA - ATLAS

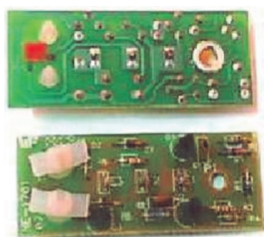

SHPE 874 - Placa do botão de chamada sensitive

PLACA ELETRÔNICA - ATLAS



SHPE 875 - Placa do botão EM / AL

PLACA ELETRÔNICA - ATLAS



SHPE 876 - Placa taco buffer JVO 228

PLACA ELETRÔNICA - ATLAS

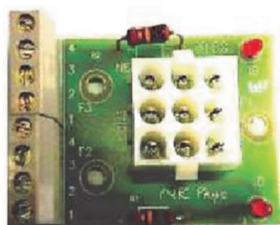

SHPE 877 - Placa interface sensor óptico

PLACA ELETRÔNICA - ATLAS

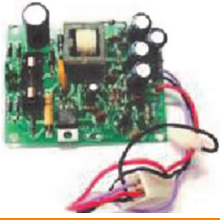

SHPE 878 - Placa fonte chaveada

PLACA ELETRÔNICA - ATLAS



SHPE 879 - Placa IPD excell 231 (20 mm)

PLACA ELETRÔNICA - ATLAS



SHPE 880 - Placa EX micro curso (conector 4 vias)
SHPE 881 - Placa MX micro curso (conector 3 vias)

PLACA ELETRÔNICA - ATLAS



SHPE 882 - Placa do botão multiled JVO 190

PLACA ELETRÔNICA - ATLAS



SHPE 883 - Placa do botão multiled JVO 153

PLACA ELETRÔNICA - ATLAS

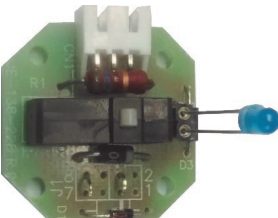

SHPE 884 - Placa do botão multiled JVO 228

PLACA ELETRÔNICA - ATLAS

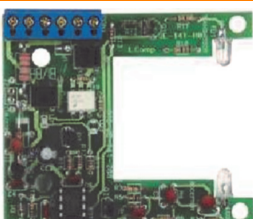

SHPE 885 - Placa sensor 5 110V (Instrutec)

PLACA ELETRÔNICA - ATLAS

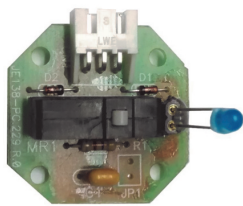

SHPE 886 - Placa do botão Multiled JVO 229 com 1 micro

PLACA ELETRÔNICA - ATLAS

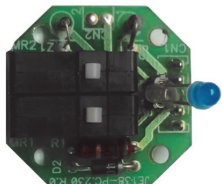

SHPE 887 - Placa do botão Multiled JVO 230 com 2 micros

PLACA ELETRÔNICA - KONE

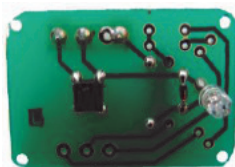
SHPE 888 - Painel de chamada 1 LED 24V
SHPE 889 - Painel de chamada 1 LED 60V

PLACA ELETRÔNICA - KONE

SHPE 890 - Painel de chamada 3 LED's 24V
SHPE 891 - Painel de chamada 3 LED's 60V

PLACA ELETRÔNICA - OTIS

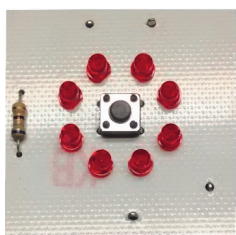

SHPE 892 - Placa botão ADV vermelho 30V

PLACA ELETRÔNICA - OTIS

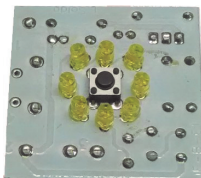

SHPE 893 - Placa botão 130V com tiristor, micro e LED amarelo

Aplicado no botão seletron / modelinho

PLACA ELETRÔNICA - OTIS



SHPE 894 - Barra do seletor - 6843 - AY1 - Marrom
SHPE 895 - Barra do seletor - 6843 - AY2 - Vermelho
SHPE 896 - Barra do seletor - 6843 - AY3 - Laranja
SHPE 897 - Barra do seletor - 6843 - AY4 - Amarelo
SHPE 898 - Barra do seletor - 6843 - AY5 - Verde
SHPE 899 - Barra do seletor - 6843 - AY6 - Azul
SHPE 900 - Barra do seletor - 6843 - AY7 - Violeta

PLACA ELETRÔNICA - OTIS



SHPE 901 - Placa ACP

PLACA ELETRÔNICA - OTIS

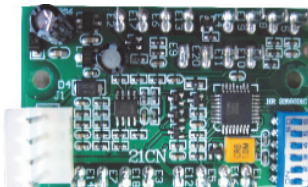

SHPE 902 - Placa RS 5

PLACA ELETRÔNICA - OTIS



SHPE 903 - Placa RS 11

PLACA ELETRÔNICA - OTIS

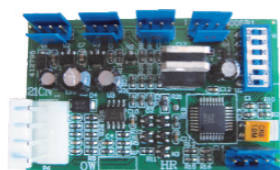

SHPE 904 - Placa RS 14

PLACA ELETRÔNICA - OTIS

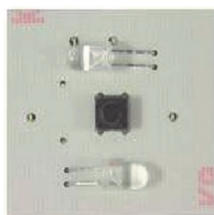

SHPE 905 - Painel de chamada vermelho BAA26800V1
SHPE 906 - Painel de chamada azul BAA26800V

PLACA ELETRÔNICA - OTIS

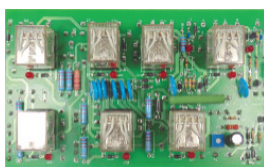

SHPE 907 - Painel PGC com relé
SHPE 909 - Painel PGC sem relé

PLACA ELETRÔNICA - OTIS

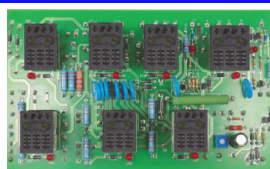

SHPE 910 - Placa painel PGC sem relé (antiga)

PLACA ELETRÔNICA - OTIS



SHPE 911 - Placa montada PRF (BO6843AT)

PLACA ELETRÔNICA - OTIS



SHPE 912 - Placa montada J3P (BO6840DA2)

PLACA ELETRÔNICA - OTIS

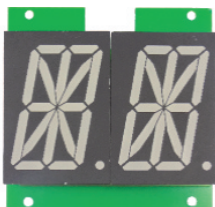

SHPE 913 - Placa montada 26800 BB (57 mm)

PLACA ELETRÔNICA - OTIS

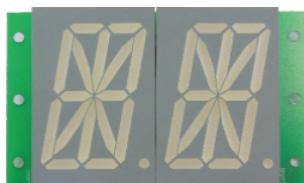

SHPE 914 - Placa montada 26800 DF (57 mm)

PLACA ELETRÔNICA - OTIS

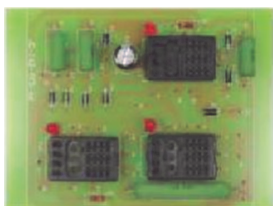
SHPE 915 - Placa PFS sem relé (BOA6843AX)
SHPE 916 - Placa PFS com relé (BOA6843AX)

PLACA ELETRÔNICA - OTIS



SHPE 917 - Placa 26 EX-R vermelho (BAA26800EX) (20mm)

PLACA ELETRÔNICA - OTIS



SHPE 918 - Placa 26 EX-B azul (BAA26800EX) (20 mm)

PLACA ELETRÔNICA - OTIS

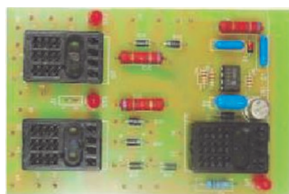

SHPE 919 - Placa PST-FR com relé (BO6843AV)
SHPE 920 - Placa PST-FR sem relé (BO6843AV) (foto)

PLACA ELETRÔNICA - THYSSEN



SHPE 921 - Placa MCINV4

PLACA ELETRÔNICA - THYSSEN



SHPE 922 - Placa M4RS

PLACA ELETRÔNICA - THYSSEN



SHPE 923 - Placa M6RS

PLACA ELETRÔNICA - THYSSEN

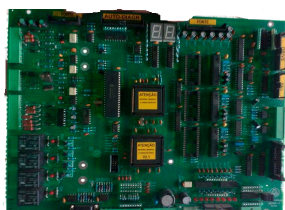

SHPE 924 - Placa MCINV2

PLACA ELETRÔNICA - OTIS



SHPE 925 - Placa 268AM-2 vermelho (BAA26800AM2) (26mm)

PLACA ELETRÔNICA - ATLAS

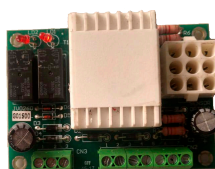

SHPE 926 - Interface do sensor Atlas com renivelamento JVO 260

PLACA - THYSSEN

SHPE 927 - Placa PSC L1

SHPE 928 - Placa PSC L2

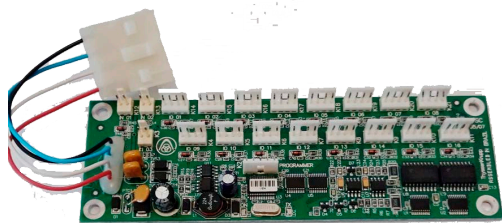

PLACA - THYSSEN

SHPE 1072 - Placa MCP5



PLACA - SCHINDLER

SHPE 929 - Placa PGO miconic SX

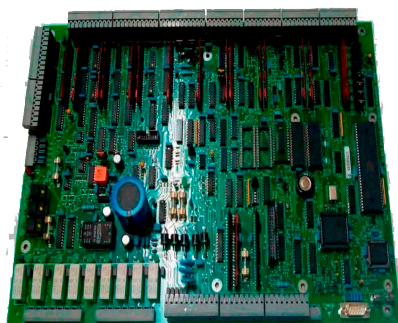

PLACA - THYSSEN

SHPE 930 - Placa MCOP3



PLACA - SCHINDLER

SHPE 931 - Placa BE1 KA

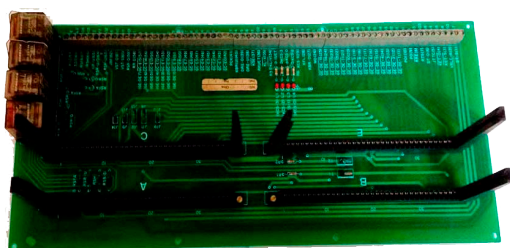

Print principal Miconic E

PLACA ELETRÔNICA - OTIS



SHPE 932 - Placa LCB II

PLACA ELETRÔNICA - OTIS

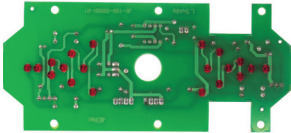

SHPE 933 - Placa carrinho Otis seta vermelha

PLACA ELETRÔNICA - OTIS

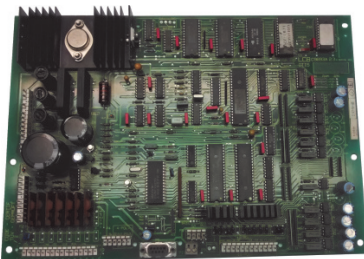

SHPE 934 - Placa Otis G1 LCB I

PLACA ELETRÔNICA - OTIS

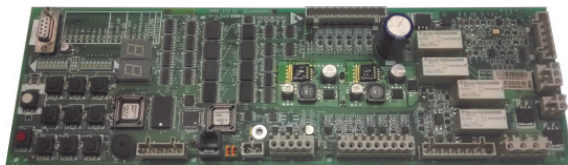

SHPE 935 - Placa SPBCIII G1 GCA 26800KX1 (GEN 2 Otis)

PLACA ELETRÔNICA - SCHINDLER

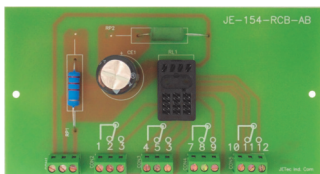

SHPE 936 - Placa temporizadora RCB JE-154 sem relê

PLACA ELETRÔNICA - SCHINDLER



SHPE 937 - Placa temporizadora RCB JE-154 com relê

PLACA ELETRÔNICA - SCHINDLER

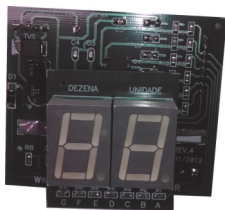

SHPE 938 - Placa IPDM 6/7 indicador de posição

Utilizado em elevadores das linhas MICONIC-E, SX e LX

PLACA ELETRÔNICA - SCHINDLER



SHPE 939 - Placa IPMPU indicador de posição de matriz de ponto

Utilizado em elevadores das linhas MICONIC-SX e LX

PLACA ELETRÔNICA - SCHINDLER

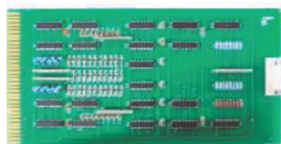

SHPE 940 - Módulo gerenciador de chamada de cabina e pavimento (GEC)

Utilizado em elevadores das linhas MICONIC-SX e LX

PLACA ELETRÔNICA - SCHINDLER

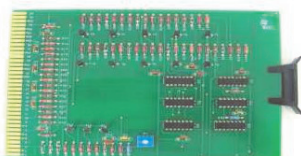

SHPE 941 - Módulo para Duplex (SZG)

Utilizado em elevadores da linha MICONIC-E

PLACA ELETRÔNICA - SCHINDLER

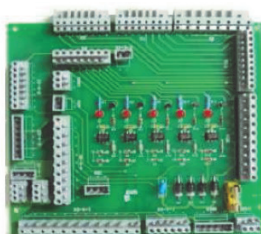

SHPE 942 - Módulo interface (CRIPFA)

Utilizado em elevadores da linha MICONIC-LX

PLACA ELETRÔNICA - THYSSEN

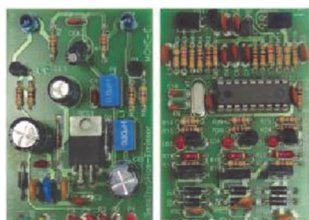

SHPE 943 - Placa sensor 5 fios

PLACA ELETRÔNICA - SCHMERSAL

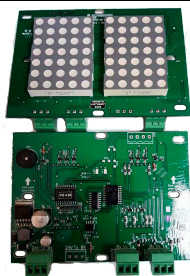

SHPE 944 - Display matriz led 50mm cn222 vermelho

SHPE 945 - Display matriz led 50mm cn222 azul

PLACA ELETRÔNICA - THYSSEN



SHPE 946 - Placa NPR-31-FIF - Falta inversão de fase

PLACA ELETRÔNICA - SCHMERSAL

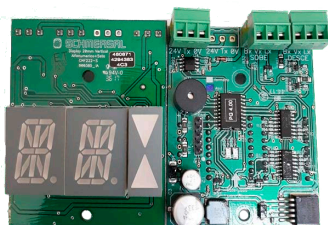

SHPE 947 - Display 20mm alfanumerico cn222 vermelho

SHPE 948 - Display 20mm alfanumerico cn222 azul

PLACA ELETRÔNICA - THYSSEN

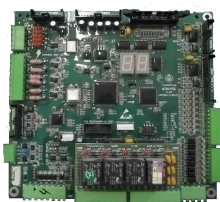

SHPE 949 -Placa MCINV5SL SEM CAN

SHPE 950 - Placa MCINV5SL COM CAN

PLACA ELETRÔNICA - THYSSEN

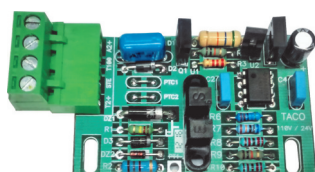

SHPE 951 - Módulo Taco contador de pulso do motor

PLACA ELETRÔNICA - THYSSEN

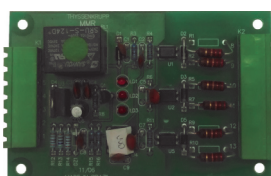

SHPE 952 - Placa módulo MMR (3Z.0598.W.3)

PLACA ELETRÔNICA - THYSSEN



SHPE 953 - Placa módulo MBMC (X.08.063.037)

PLACA ELETRÔNICA - INFOLEV

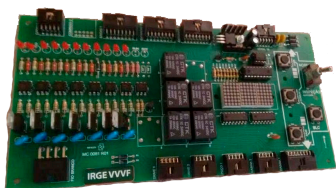

SHPE 954 - Placa IRGE VVVF

PLACA ELETRÔNICA - THYSSEN

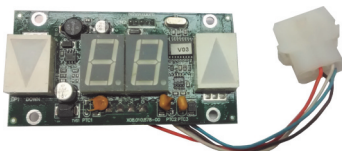

SHPE 955 - Placa módulo IPD TK99HS (3Z.0598.CH1)

PLACA ELETRÔNICA - THYSSEN



SHPE 956 - Placa módulo MC04S (3Y.6503.RX.4)

PLACA ELETRÔNICA - THYSSEN



SHPE 957 - Módulo pré-carga (RESC)

Utilizado em elevadores da linha FDN

PLACA ELETRÔNICA - THYSSEN

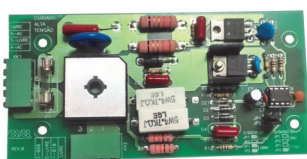

SHPE 958 - Placa controle de freio JE 140-1 MACB

135V e 200V

Com diodo e controlador

PLACA ELETRÔNICA - THYSSEN

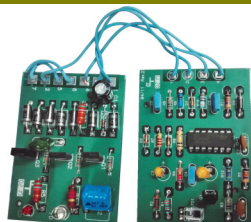

SHPE 959 - Placa circuito chave eletrônica 24V indicador

SHPE 960 - Placa circuito chave eletrônica 110V

Utilizado em elevadores das linhas MCP-5, AC2 e MCP-7

PLACA ELETRÔNICA - THYSSEN

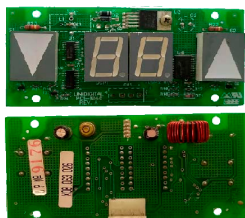

SHPE 961 - Display SF1 usado no MCP6

PLACA - INFOLEV

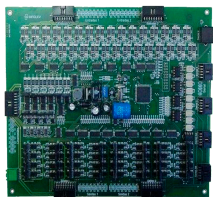

SHPE 962 - Placa Infolev Genius

PLACA - INFOLEV



SHPE 963 - Placa fonte freio infolev

PLACA - INFOLEV



SHPE 964 - Display IPDMG infolev

PLACA - INFOLEV



SHPE 965 - IPDMCS display azul para botoeira
 SHPE 966 - IPDMCS display vermelho para botoeira

PLACA - ATLAS

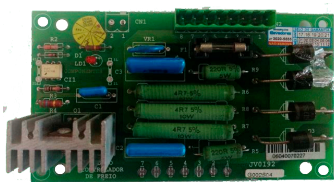

SHPE 967 - Placa controlador freio JVO 192

PLACA SCHMERSAL

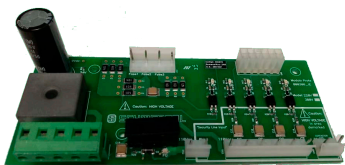

SHPE 968 - Placa de segurança e fonte

PLACA SCHMERSAL



SHPE 969 - Placa I/O

PLACA SCHMERSAL



SHPE 970 - Placa de rele CN222

PLACA SCHMERSAL

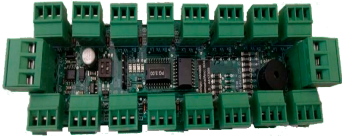

SHPE 971 - Placa Totem

PROTETOR DA POLIA



SHPE 1160 - Acabamento da polia de tração S001 em baixo da cabine

PROTETOR DA POLIA



SHPE 1161 - Acabamento da polia de contra peso S001

PROTETOR ANTISSURTO



SHPE 972 - Protetor Antissurto trifásico 220V
SHPE 973 - Protetor Antissurto trifásico 380V

REPETIDOR



SHPE 974 - Repetidor de quadro AC2

REED SWITCH



SHPE 975 - Reed switch SM 1001

RELOGIO DIGITAL



SHPE 976 - Relógio digital com software TKE

RETENTOR - THYSSEN



SHPE 977 - Retentor de 2 labios da polia da máquina EM 25

RESISTOR DE FRENAGEM

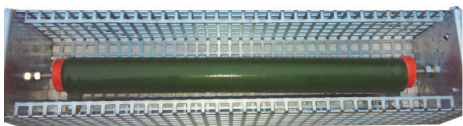

SHPE 978 - Resistor de frenagem

Atendemos qualquer especificação

ROLAMENTO POLIA

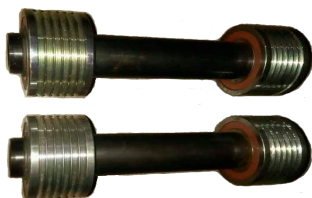

SHPE 979 - Polia S001 com eixo (Foto)

SHPE 980 - Polia S001 sem eixo

ROLDANA

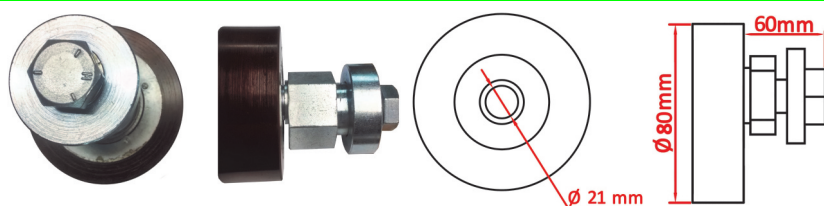

SHPE 981 - Roldana para arcada 80 mm (Foto)

SHPE 982 - Roldana para arcada 150 mm

Acompanha eixo e parafuso

ROLDANA - FERMATOR

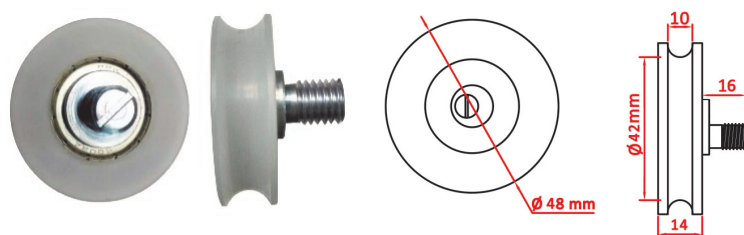

SHPE 983 - Roldana com eixo excêntrico 48mm

tipo Fermator

ROLDANA - FERMATOR

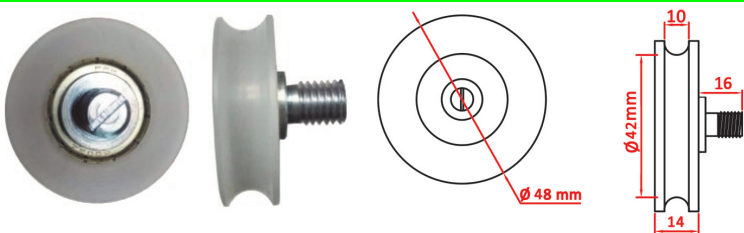

SHPE 984 - Roldana com eixo concêntrico 48mm

tipo Fermator

ROLDANA - SELCOM

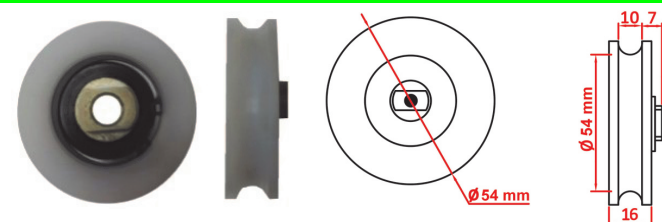

SHPE 985 - Roldana tipo Selcom 54mm

ROLDANA - THYSSEN



SHPE 1173- Roldana superior D60

ROLDANA - ATLAS

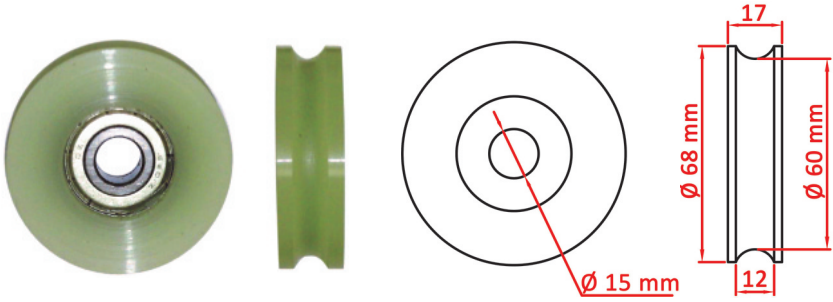

SHPE 986 - Para porta de cabina 68 mm

ROLDANA - KONE

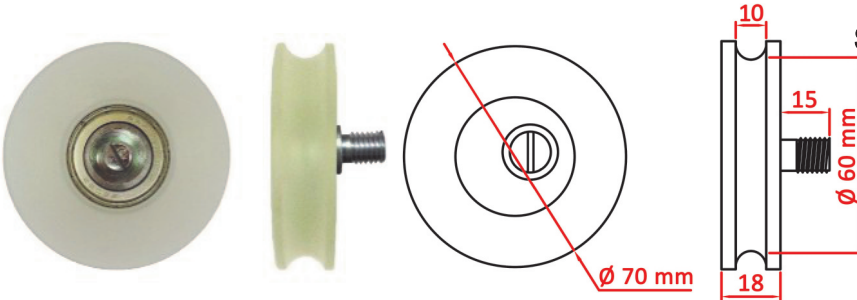

SHPE 987 - Para suspensão de porta de cabina
70 mm canal abaulado com eixo

ROLDANA - KONE

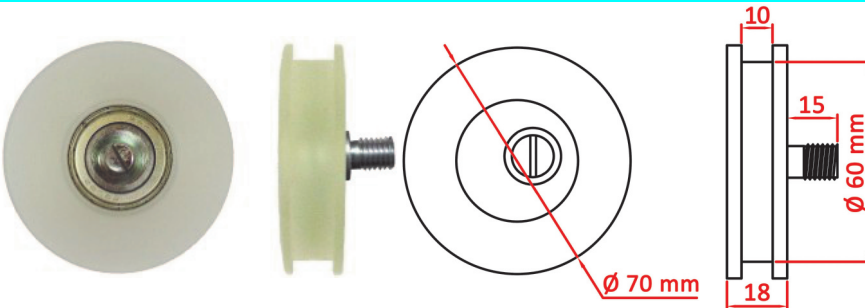

SHPE 988 - Para suspensão de porta de cabina
70 mm canal reto com eixo

ROLDANA - KONE

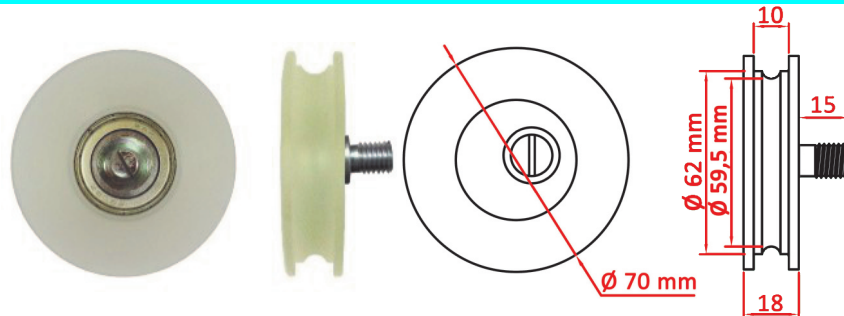

SHPE 989 - Para suspensão de porta de cabina
70 mm com eixo

ROLDANA - KONE

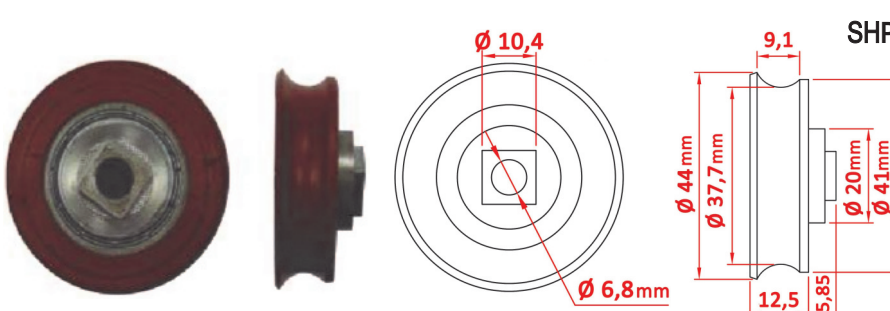

SHPE 990 - Roldana de pavimento 44 mm

ROLDANA - OTIS

SHPE 991 - Roldana para carrinho seletor 20 mm

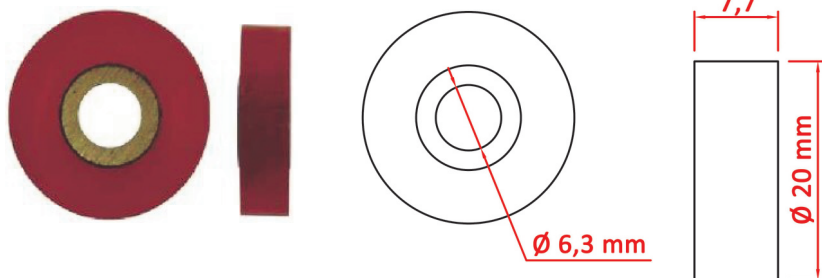

ROLDANA - OTIS

SHPE 992- Roldana para porta de cabina 50 mm

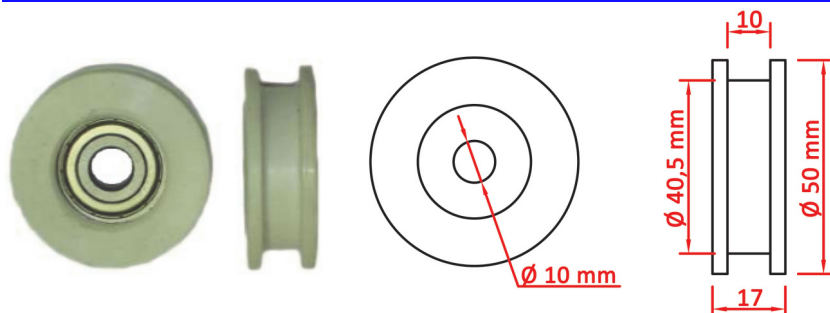

ROLDANA - OTIS

SHPE 993 - Roldana com eixo excêntrico 50 mm

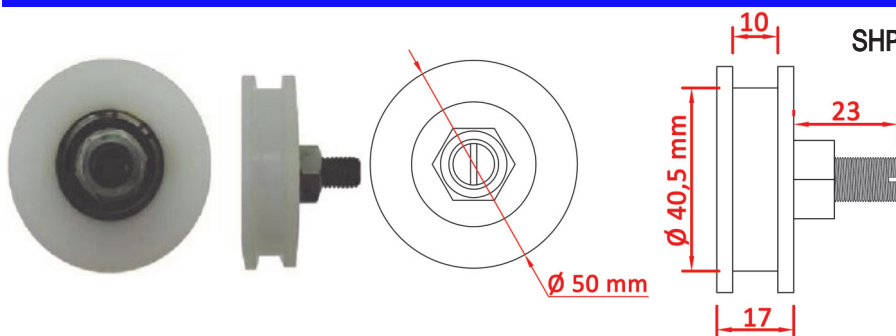

ROLDANA - OTIS

SHPE 994 - Roller guide alumínio AJ2

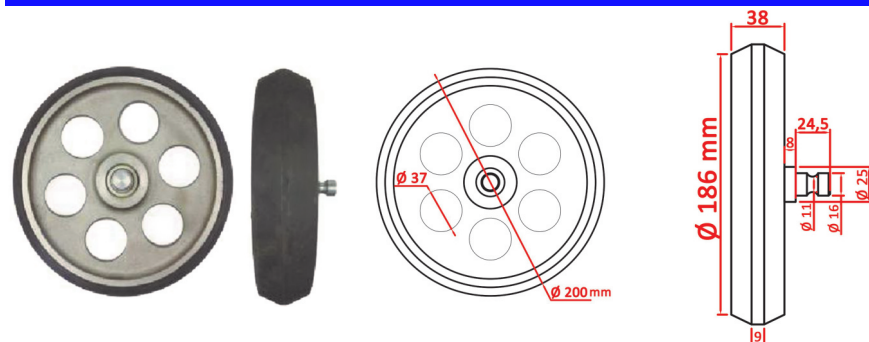

ROLDANA - OTIS

SHPE 995 - Roldana para contrapeso 20 mm/95 mm

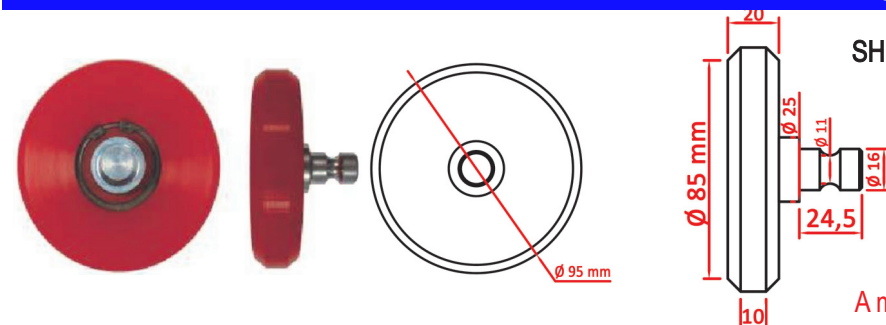

A medida 20 mm refere-se a espessura da roldana

ROLDANA - OTIS

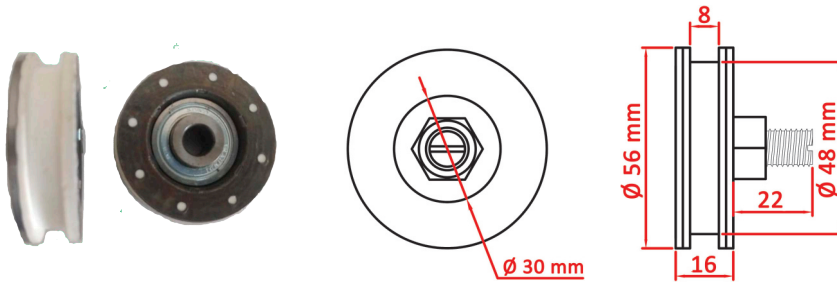

SHPE 996- Roldana para porta modelo
At120 56 mm original

ROLDANA - OTIS

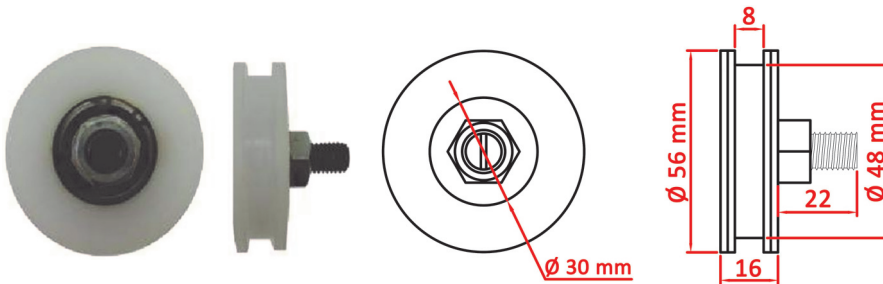

SHPE 997 - Roldana para porta similar
At120 56 mm

ROLDANA - OTIS

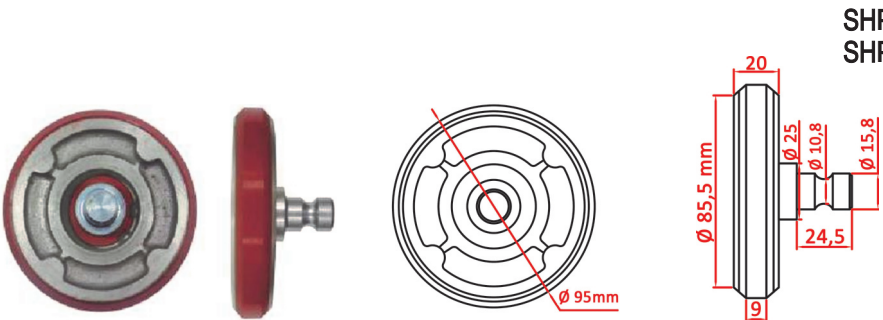

SHPE 998 - Roldana para contra-peso 20 x 95 mm
SHPE 999 - Roldana para contra-peso 28 x 95 mm

ROLDANA - OTIS

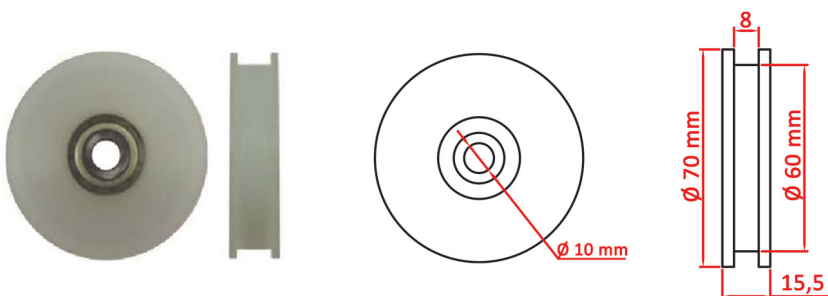

SHPE 1000 - Roldana de porta 70 mm

ROLDANA - OTIS

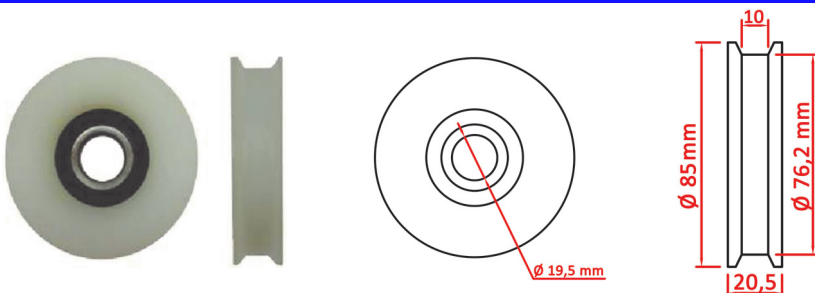

SHPE 1001 - Roldana de porta 85 mm

ROLDANA - OTIS

SHPE 1002- Roldana (FO456FJ1)

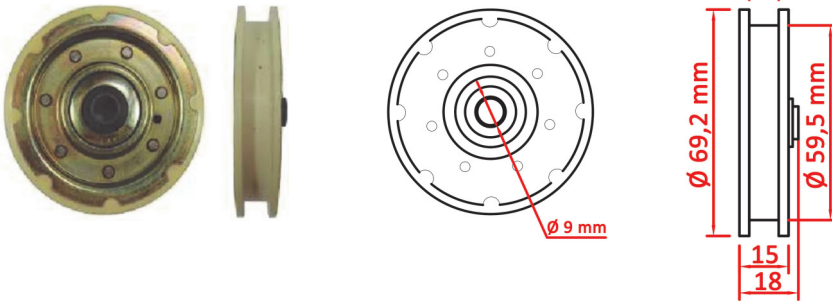
**ROLDANA - OTIS**

SHPE 1003 - Roldana de borracha para trinco

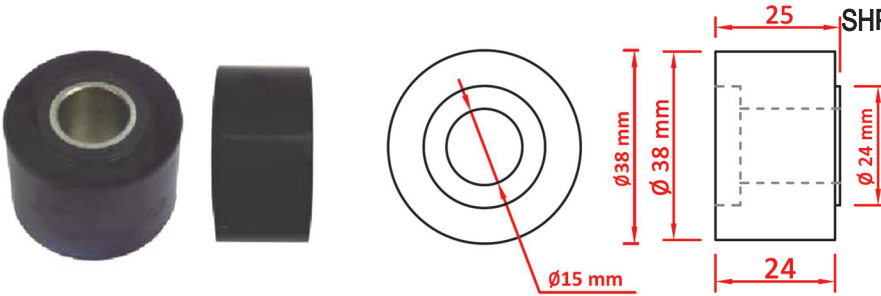
**ROLDANA - OTIS**

SHPE 1004- Roldana de nylon com eixo 70 mm

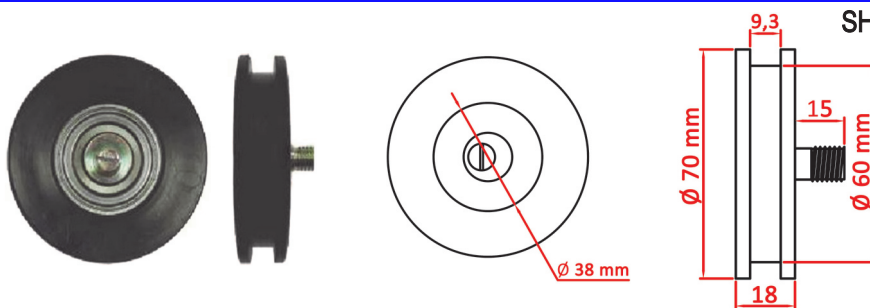
**ROLDANA - OTIS**

SHPE 1005- Roldana metálica 70 mm

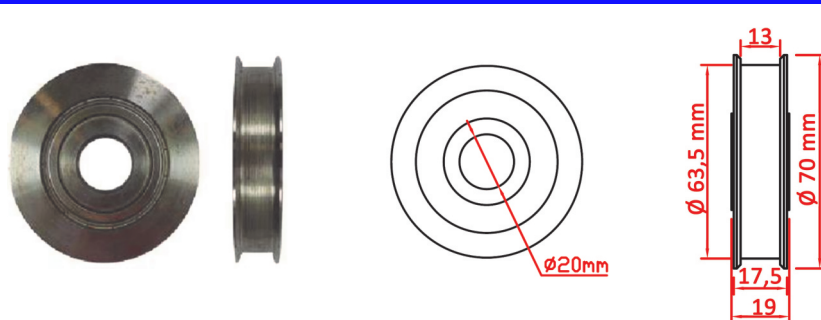
**ROLDANA - OTIS**

SHPE 1006- Roldana metálica 82 mm

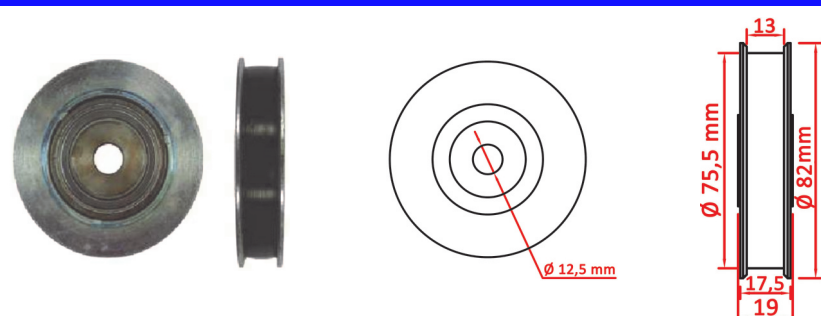

ROLDANA - OTIS

SHPE 1007 - Roldana metálica 85 mm

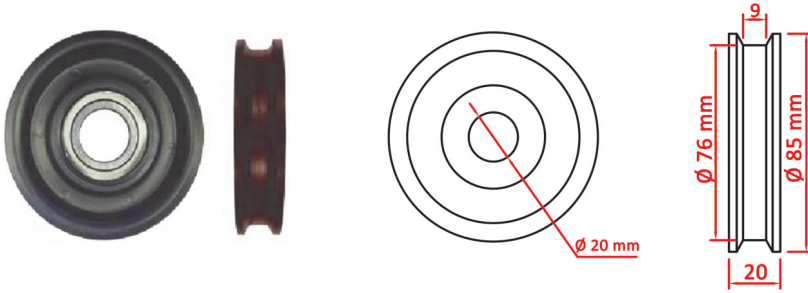

ROLDANA - OTIS

SHPE 1008 - Roldana metálica 140 mm

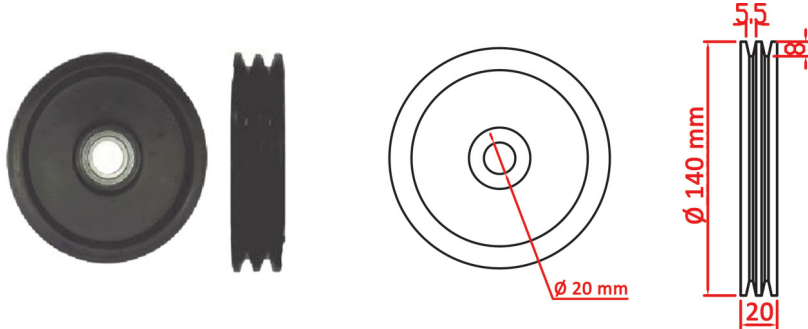

ROLDANA - OTIS

SHPE 1009 - Roldana de borracha para limitador de velocidade Ø 49,5 mm

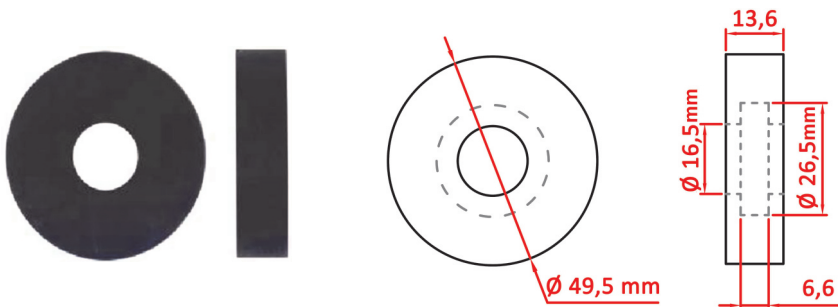

ROLDANA - OTIS

SHPE 1010 - Roldana com bucha para cabo

operador porta 54 mm

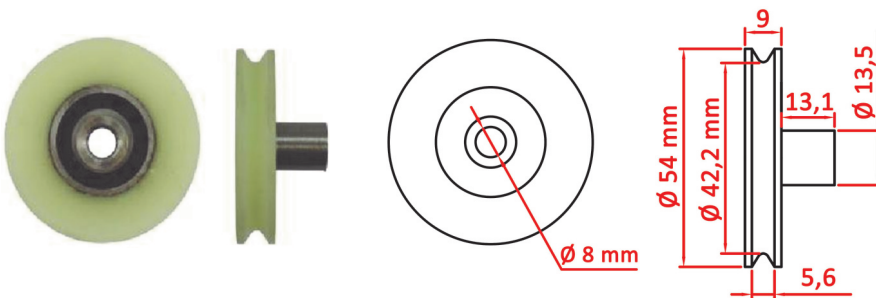

ROLDANA - OTIS

SHPE 1011 - Roldana sem bucha para cabo

operador porta 54 mm

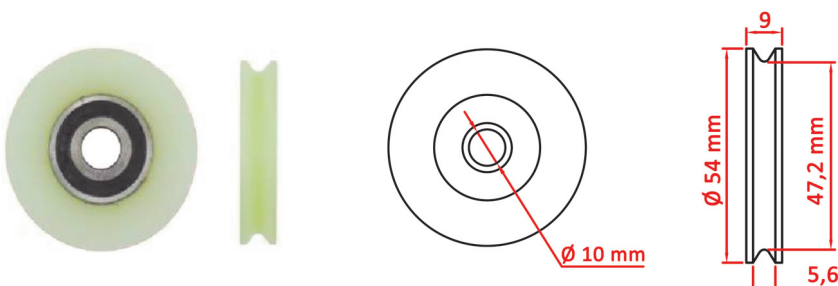

ROLDANA - SCHINDLER

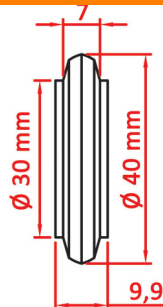
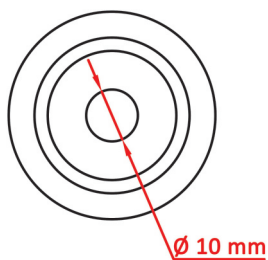
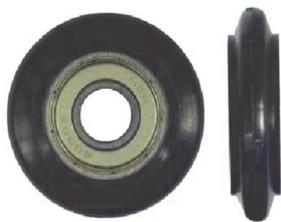

SHPE 1012 - Roldana suspensão de porta 40 mm

QK8

ROLDANA - SCHINDLER

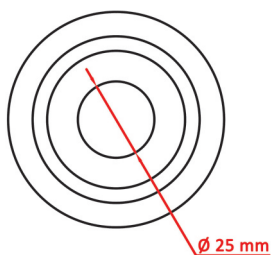

SHPE 1013 - Roldana suspensão de porta 75 mm

QKS2

ROLDANA - SCHINDLER

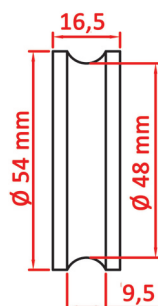
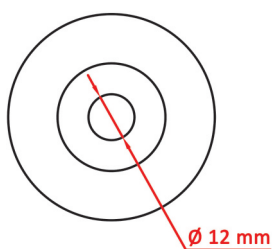
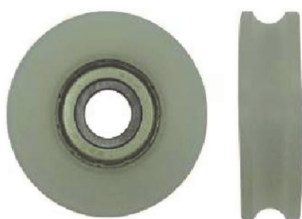

SHPE 1014 - Roldana para porta de cabina 54 mm

ROLDANA - SCHINDLER

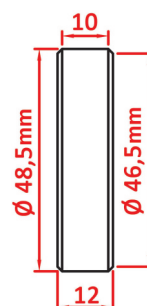
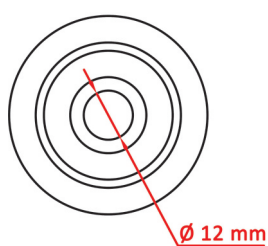

SHPE 1015 - Roldana de borracha para operador

 $\varnothing 48,5 \text{ mm}$

ROLDANA - SCHINDLER

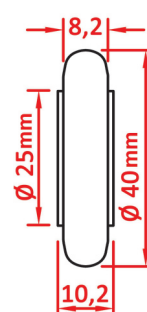
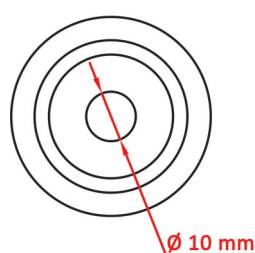

SHPE 1016 - Roldana de nylon para porta 40 mm

ROLDANA - SCHINDLER

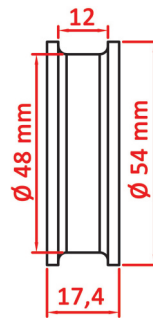
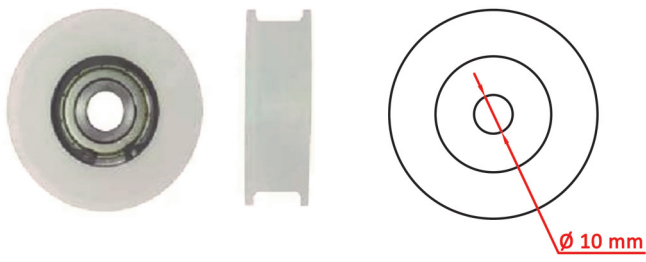

SHPE 1017- Roldana mecanismo de porta miconic 54 mm

ROLDANA - SCHINDLER

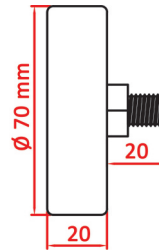
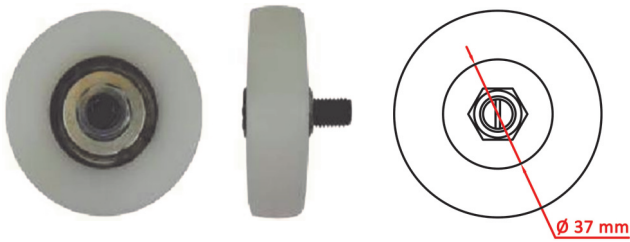

SHPE 1018- Roldana mecanismo de porta miconic 70 mm

ROLDANA - SELCOM

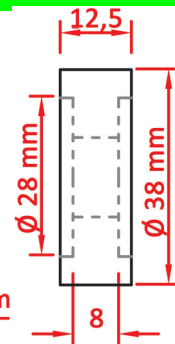

SHPE 1019- Roldana de borracha do operador de porta Ø 38 mm

ROLDANA - SELCOM

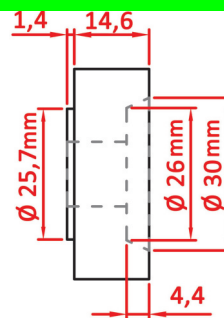
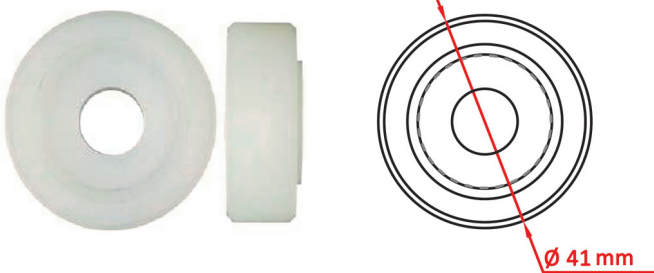

SHPE 1020- Roldana superior 41 mm

ROLDANA - SUR

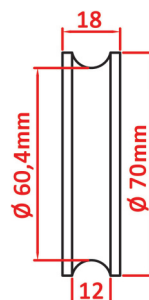
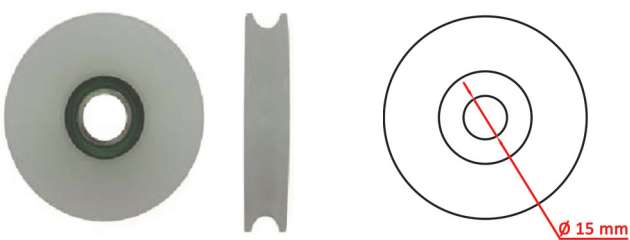

SHPE 1021- Roldana para porta de cabina 70 mm

ROLDANA - SUR

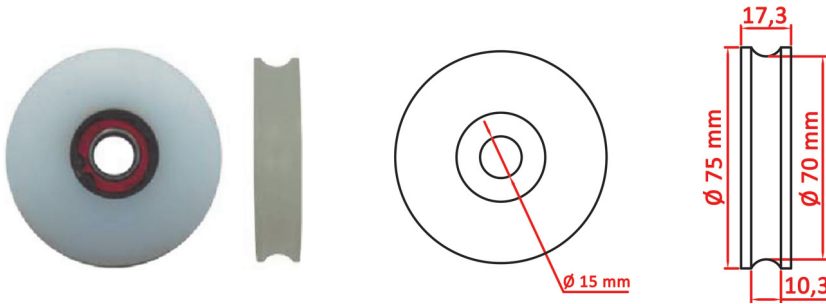

SHPE 1022 - Roldana para porta de cabina 75 mm

ROLDANA - THYSSEN

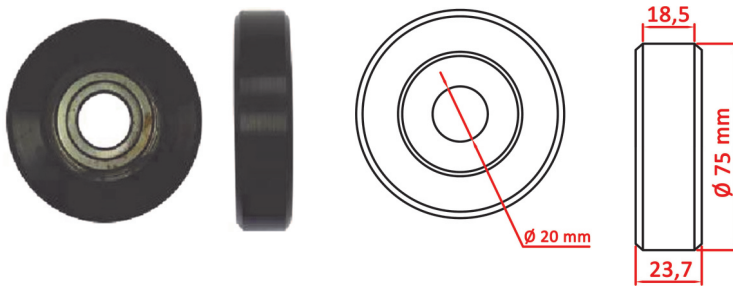

SHPE 1023 - Roldana para degrau pallet 75 mm

SHPE 1024 - Roldana para degrau pallet 75 mm
somente a borracha

ROLDANA - THYSSEN

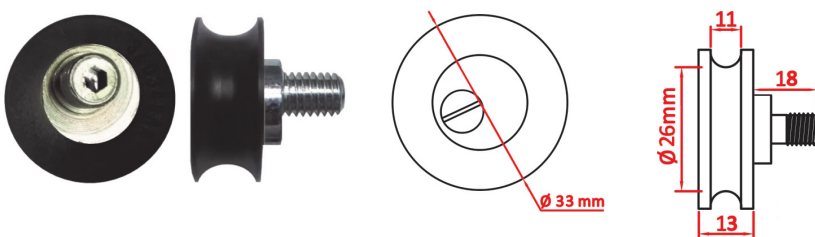

SHPE 1025 - Roldana excêntrica D 33 mm PFR-04

ROLDANA - THYSSEN

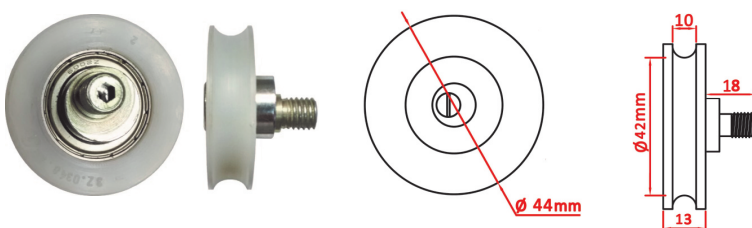

SHPE 1026 - Roldana inferior 44 mm completa

ROLDANA - OTIS



SHPE 1191 - Roldana da rampa DO 2000

ROLDANA - WITTUR

SHPE 1027 - Roldana para destravar o trinco

ROLDANA - THYSEN

SHPE 1028- Roldana para dispositivo de arraste 38 mm

ROLDANA - WITTUR

SHPE 1029- Roldana wittur 56 mm

ROLDANA - WITTUR

SHPE 1030- Roldana excêntrica inferior D43 mm

ROLDANA - WITTUR

SHPE 1031 - Roldana superior 45mm augusta

ROLDANA - WITTUR

SHPE 1171 - Roldana inferior 34mm augusta

ROLDANA - WITTUR

SHPE 1172- Roldana superior 45mm augusta

RETIFICADOR

SHPE 1032- Ponte retificadora trifásica

SHPE 1033 - ponte retificadora monofásica

SAPATA DE FREIO

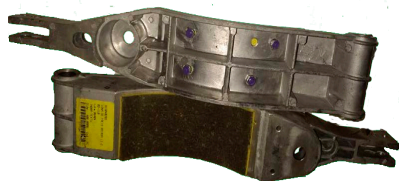

SHPE 1034 - Sapata de freio maquina W140

SAPATA DE FREIO



SHPE 1035 - Sapata de freio maquina W163

SAPATA DE FREIO

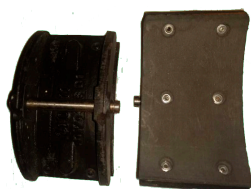

SHPE1036 - Sapata de freio com lona EM33

SAPATA DE FREIO

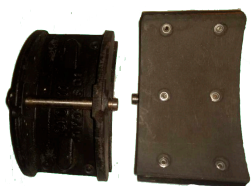

SHPE 1037 - Sapata de freio com lona EM 25

SENSOR - SCHMERSAL

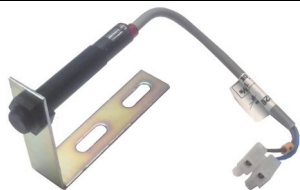

SHPE 1038 - Sensor tubular magnético NA 197224

SHPE 1039 - Sensor tubular magnético biestável 197802

SENSOR - SCHMERSAL



SHPE 1040 - Sensor IFO-U 24-11 P 164195

SHPE 1041 - Sensor IFO-U 24-11 N 164196 (foto)

SENSOR - SCHMERSAL



SHPE 1042 - Sensor BN-31 RZ biestável 197003

SENSOR - SCHMERSAL

SHPE 1043 - Sensor BN8010Z NA 187006



SENSOR - SCHMERSAL

SHPE 1044 - Sensor magnético BN325R 193285



SENSOR - THYSSEN

SHPE 1045 - Sensor Eletrônico tipo Hall PNP 15-60 VDC



SENSOR - OTIS

SHPE 1046 - Sensor Balluf NA
SHPE1047 - Sensor Balluf NF



SENSOR - THYSSEN

SHPE 1048 - Chave eletrônica 24 Vcc 3 fios



SENSOR - THYSSEN

SHPE 1049 - Chave eletrônica 110 vcc 3 fios



SENSOR - THYSSEN

SHPE 1050 - Chave eletrônica para limite linear 5 fios

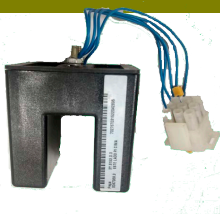

SENSOR - SCHINDLER



SHPE 1051 - Chave magnética biestavel

SENSOR - SCHINDLER



SHPE 1052 - Sensor GLS S001

SENSOR - ATLAS



SHPE 1053- Sensor óptico atlas excel

SENSOR METÁLICO



SHPE 1054 - Sensor magnético 1 NA 06-36 VDC
 SHPE 1055 - Sensor magnético 1 NA 24-220 VDC
 SHPE 1056- Sensor magnético 1 NA 90-250 VDC
 SHPE 1057 - Sensor magnético 1 NA 90-220 VAC

SENSOR - THYSSEN



SHPE 1058- Sensor magnético blindado

SENSOR



SHPE 1059- Sensor magnético 100mA 1 NA 60 VDC

SENSOR - OTIS



SHPE 1060 - Sensor RBI cinta do GEN2

SENSOR - THYSSEN

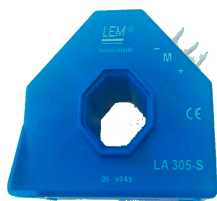

SHPE 1061 - Sensor de efeito Hall 300A

SETA DISPLAY - THYSSEN

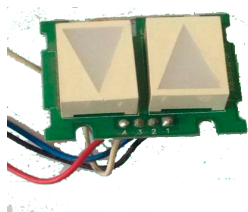

SHPE 1062 - Modulo seta SETBM com rabicho

SETA DISPLAY - ATLAS

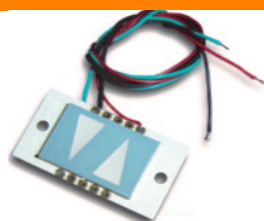

- SHPE 1063 - Seta display vermelha 6V
- SHPE 1064 - Seta display vermelha 12V
- SHPE 1065 - Seta display vermelha 24V
- SHPE 1066 - Seta display vermelha 100V

SETA DISPLAY - SCHINDLER

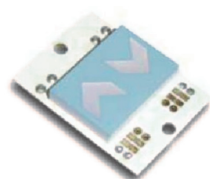

- SHPE 1067 - Seta display dupla azul
- SHPE 1068 - Seta display dupla vermelha

SUORTE

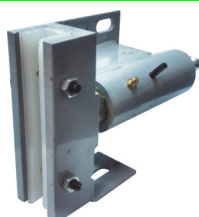

- SHPE 1069 - Suporte para corrediça modelo GS 10 mm (foto)
- SHPE 1070 - Suporte para corrediça modelo GS 16 mm

SUORTE



- SHPE 1071 - Suporte corrediça contra peso guia 10mm
- SHPE 1072 - Suporte corrediça cantra peso guia 16mm

com nylon

SUORTE



- SHPE 1073 - Suporte corrediça cabine guia de 10mm
- SHPE 1074 - Suporte corrediça cabina guia de 16mm

com nylon

SUPORTE



SHPE 1075- Suporte com corredeira S001

SUPORTE



SHPE 1076- Suporte para limite fim de curso

SUPORTE - ATLAS



SHPE 1077 - Suporte para corredeira contra-peso

Trabalha com as corredeiras SHPE 562, SHPE 564 e SHPE 565

SUPORTE - ATLAS



SHPE 1078 - Suporte para corredeira de cabina

Trabalha com as corredeiras SHPE 563 e SHPE 563

SUPORTE - ATLAS



SHPE 1079 - Suporte para corredeira sapatilha

Trabalha com a corredeira SHPE 611

SUPORTE - OTIS



SHPE 1080 - Suporte de cabina modelinho

Trabalha com a corredeira SHPE 571

SUPORTE - OTIS



SHPE 1081 - Suporte do contra-peso modelinho

Trabalha com a corredeira SHPE 571

SUORTE CORREDIÇA



SHPE 1177 - Corrediça contra peso S001 10mm
SHPE 1180 - Corrediça contra peso S001 16mm

SUORTE CORREDIÇA



SHPE 1181 - Corrediça contra peso S001 10mm padrão cabina
SHPE 1182 - Corrediça contra peso S001 16mm padrão cabina

SUORTE CORREDIÇA



SHPE 1183 - Corrediça contra peso S001 30mm

SUORTE CORREDIÇA



SHPE 1184 - Corrediça monta prato 10mm

SUORTE CORREDIÇA

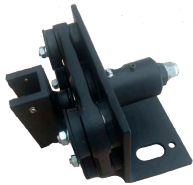

SHPE 1185 - Suporte corrediça 3Y.5272.EF.1 guia 10mm
SHPE 1186 - Suporte corrediça 3Y.5272.EF.1 guia 16mm

SUORTE CORREDIÇA

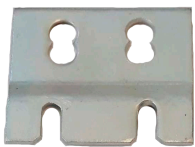

SHPE 1178 - Suporte para corrediça gravatinha

SUORTE CORREDIÇA



SHPE 1187 - Corrediça gravatinha 11mm com suporte

AMPLIFICADOR MSCC



SHPE 1188 - Corrediça gravatinha 14mm com suporte

SUPOORTE - SUR



SHPE 1082 - Suporte para corredeira sapatilha dobra fina

Trabalha com a corredeira SHPE 535

SUPOORTE - SUR



SHPE 1083 - Suporte para corredeira sapatilha dobra grossa

Trabalha com a corredeira SHPE 535

SUSPENSÃO DE PORTA - SCHINDLER



SHPE 1084 - Suspensão de porta de cabina

SUSPENSÃO DE PORTA - SCHINDLER



SHPE 1085 - QK 8 com roldana externa

SUSPENSÃO DE PORTA - SCHINDLER

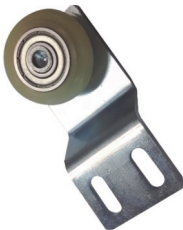

SHPE 1086 - QK 8 com roldana interna

SUSPENSÃO DE PORTA - SCHINDLER



SHPE 1087 - QK 8 com roldana interna e pino

SUSPENSÃO DE PORTA - SCHINDLER



SHPE 1088 - QK 8 com roldana reto

SUSPENSÃO DE PORTA - SCHINDLER

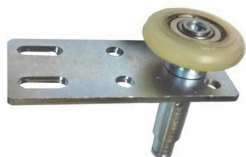

SHPE 1089 - QK 8 com roldana, reto e pino

SUPORTE DE FIXAÇÃO



SHPE 1090 - Suporte de fixação da correia do operador

SUPORTE



SHPE 1091 - Suporte pinhão esticador da correia

TECLADO - SCHINDLER



SHPE 1176 - Teclado SMLCD

TECLADO - THYSEN



SHPE 1092 - Teclado TLS

TERMOSTATO



SHPE 1093 - Termostato TKE do ventilador

TIRANTE

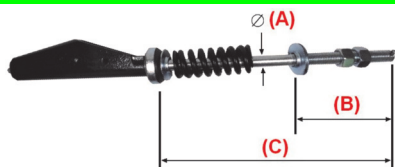

- SHPE 1094 - Com mola 5/16" 8 mm (A:12,5xB:130xC:236 mm)
- SHPE 1095 - Com mola 3/8" 9,5 mm (A:14,6xB:125xC:307,5 mm)
- SHPE 1096 - Com mola 1/2" 13 mm (A:16xB:163xC:357 mm)
- SHPE 1097 - Com mola 5/8" 16 mm (A:18,5xB:230xC:428 mm)

TIRANTE

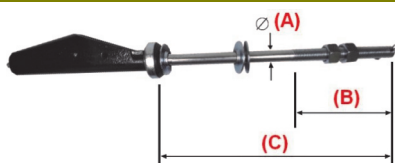

- SHPE 1098 - Sem mola 5/16" 8 mm (A:12,5xB:130xC:236 mm)
- SHPE 1099 - Sem mola 3/8" 9,5 mm (A:14,6xB:125xC:307,5 mm)
- SHPE 1100 - Sem mola 1/2" 13 mm (A:16xB:163xC:357 mm)
- SHPE 1101 - Sem mola 5/8" 16 mm (A:18,5xB:230xC:428 mm)

TRINCO



SHPE 1102 - Trinco para porta tipo Fermator esquerdo

TRINCO



SHPE 1103 - Trinco para porta tipo Fermator direito

TRINCO - ATLAS



SHPE 1104 - Trinco TV3 direito completo 197847 (foto)
SHPE 1105 - Trinco TV3 esquerdo completo 197846

TRINCO - ATLAS

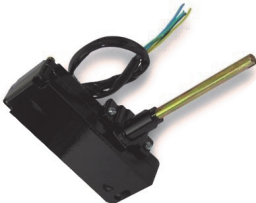

SHPE 1106 - Trinco para porta pantográfica
SHPE 1107 - Trinco para porta pantográfica esquerdo (foto)

TRINCO - THYSSEN

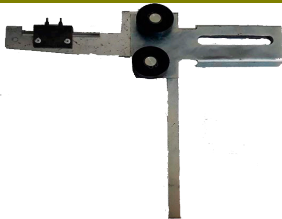

SHPE 1108 - Trinco vvf esquerdo (foto)

SHPE 1109 - Trinco vvf direito

TRINCO - ATLAS



SHPE 1110 - Trinco tipo TF2 direito 19755101 (foto)
SHPE 1111 - Trinco tipo TF2 esquerdo 19755102

TRINCO - KONE



SHPE 1112 - Trinco EV direito (foto)

SHPE 1113 - Trinco EV esquerdo

TRINCO - OTIS



SHPE 1114 - Trinco modelinho direito

SHPE 1115 - Trinco modelinho esquerdo (foto)

TRINCO - OTIS



SHPE 1116 - Miolo de trinco Otis direito

SHPE 1117 - Miolo de trinco Otis esquerdo (foto)

TIRANTE



SHPE 1118 - Tirante para rampa QKS 8 770 mm

TRINCO - MONTELE

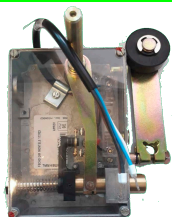

SHPE 1119 - Trinco plataforma Montele direito

SHPE 1120 - Trinco plataforma Montele esquerdo

TRINCO - THYSSEN



SHPE 1121 - Dispositivo de destravar trinco tke

TRINCO - OTIS



SHPE 1122 - Gancho para trinco AT 120 com contato

TRINCO - SCHINDLER



SHPE 1123 - Trinco EVR

TRINCO - SCHINDLER

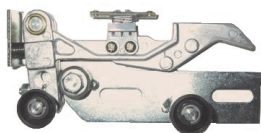

SHPE 1124- Trinco QKS-8 direito (foto)

SHPE 1125 - Trinco QKS-8 esquerdo

TRINCO - SUR



SHPE 1126- Trinco FES direito 19757002 (foto)

SHPE 1127 - Trinco FES esquerdo 19757001

TRINCO - SUR



SHPE 1128- Eletromecânico AVD mão direita 11970259 (Foto)

SHPE 1129- Eletromecânico AVE mão esquerda 11970260

URM - OTIS



SHPE 1130- URM azul

VENTILADOR

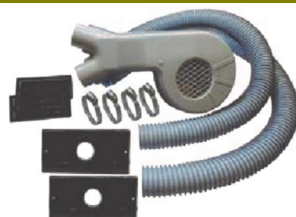

SHPE 1131 - Kit ventilação para cabina

VENTILADOR



SHPE 1132- Ventilador caracol com duas saídas

VENTILADOR



SHPE 1133- Ventilador centrifugo duas saidas ferro

VENTILADOR



SHPE 1134 - Ventilador para cabina bivolt 110V/220V sem caixa de proteção

VENTILADOR

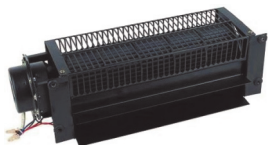

SHPE 1135 - Ventilador para cabina retangular 220V

VENTILADOR

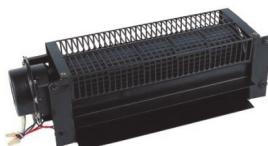

SHPE 1136 - Ventilador retangular para cabina 110V

VENTILADOR



SHPE 1137 - Ventilador caracol para maquina W140

VENTILADOR

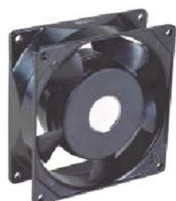

SHPE 1138 - Micro ventilador para cabina 110V / 220V
120 mm x 120 mm

VISOR



SHPE 1139 - Visor para IPD vermelho / fumê 28x40 mm

VISOR

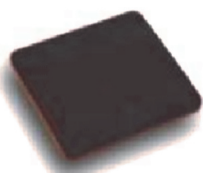

SHPE 1140 - Visor para IPD vermelho / fumê 28x45 mm

VISOR

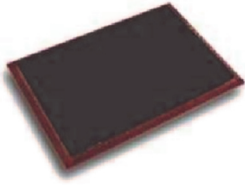

SHPE 1141 - Visor para IPD vermelho / fumê 40x60 mm

VISOR



SHPE 1142 - Visor para IPD vermelho / fumê 65x150 mm

VISOR



SHPE 1143 - Visor para IPD vermelho / fumê 65x100 mm

VISOR



SHPE 1144 - Visor para IPD vermelho / fumê 65x200 mm

VISOR



SHPE 1145 - Visor azul 51,5 x 27,5 x 1,5 mm

VISOR



SHPE 1146 - Visor vermelho 51,5 x 27,5 x 1,5 mm

VISOR

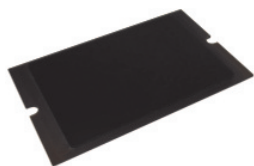

SHPE 1147 - Visor fumê 95 x 63 x 1,5 mm

VISOR - KONE



SHPE 1148 - Visor acrílico 204-B

VISOR - OTIS



SHPE 1149 - Visor vermelho para IPD 60x30x2 mm

VISOR - OTIS



SHPE 1150 - Visor vermelho para IPD 60x50x2 mm

VISOR - REAL



SHPE 1151 - Visor plástico para porta

VISOR - SCHINDLER



SHPE 1152 - Visor xadrez 300x700 mm



Shopping dos
Elevadores

www.shpe.com.br

📍 Rua Manoel Rosindo, 175, São Pedro 1, Vitória/ES

✉ contato@shpe.com.br ☎ (27) 3020-5555 📞 99234-2198